

#26 MINI 4 FLAT

1	SK	Montážny návod
2	CZ	Montážní návod
3	DE	Montageanleitung
4	ENG	Assembly instructions
5	PL	Instrukcja montażu
6	RO	Instrucțiuni de montaj
7	IT	Istruzioni di montaggio

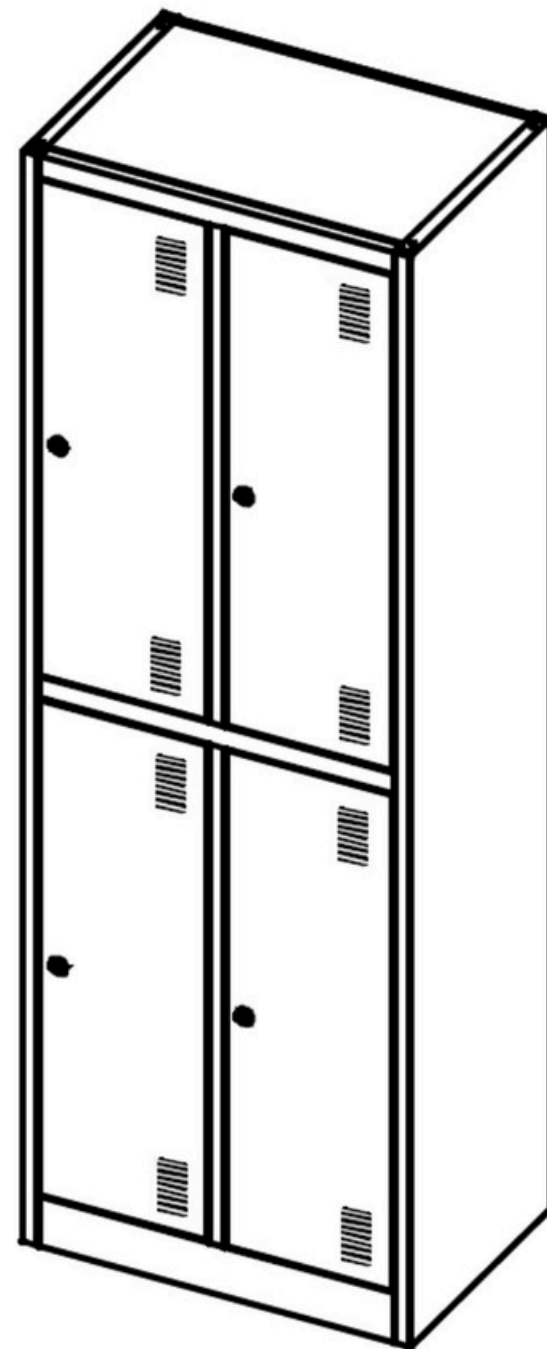

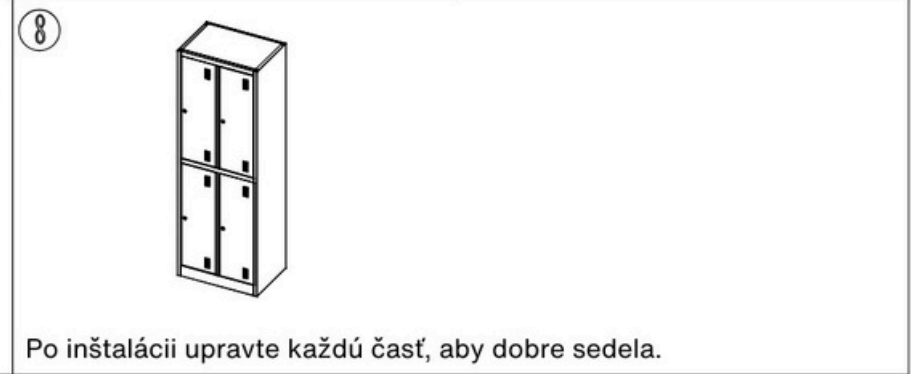

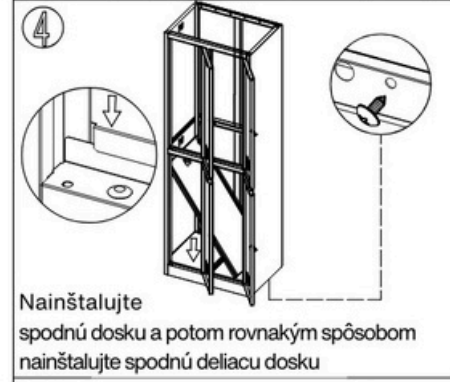
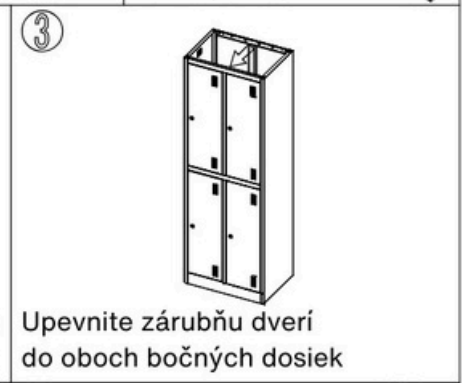
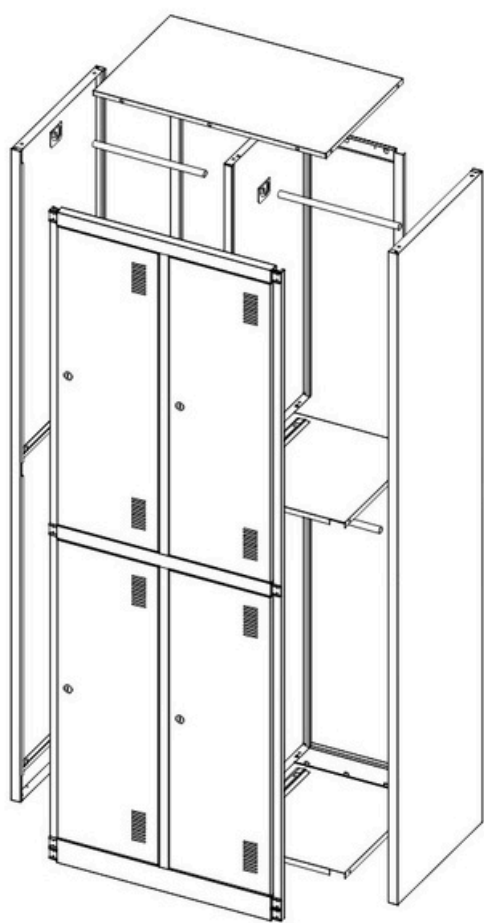
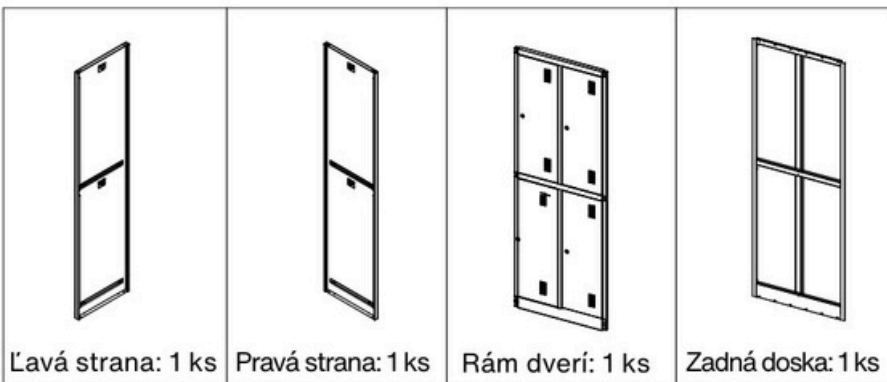

Levá strana: 1 ks



Pravá strana: 1 ks

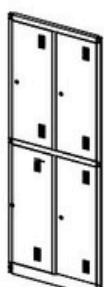

Rám dveří: 1 ks



Zadní deska: 1 ks



Vrchní deska: 1 ks



Středová deska: 1 ks



Spodní deska: 1 ks

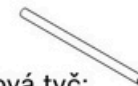

Věšáková tyč:
Levá (krátká): 2 ks
Pravá (dlouhá): 2 ks



Horní příčná deska (malá): 1 ks



Spodní příčná deska (velká): 1 ks



Samořezné šrouby
(5x10): 16 ks



Klíče: 4 sady

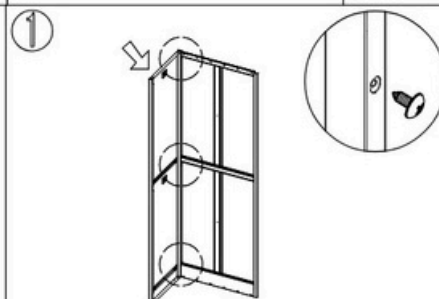
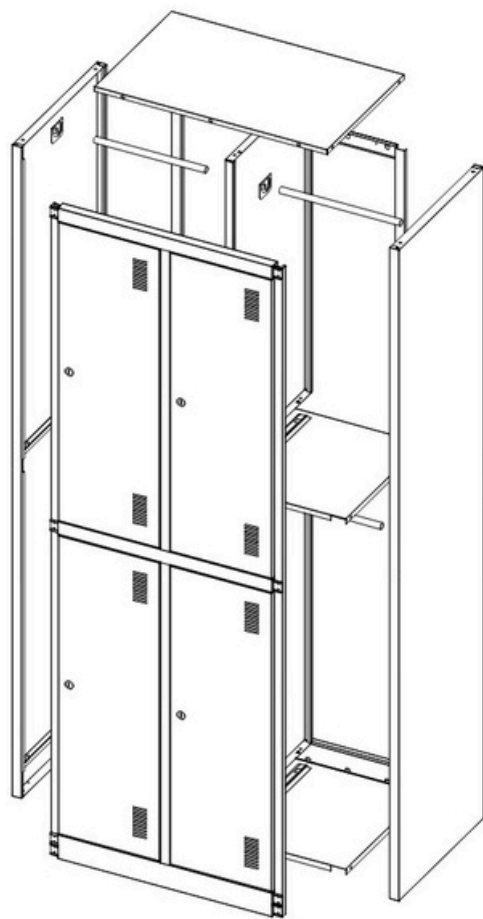

1 Přišroubujte levou stranu a zadní desku samořeznými šrouby (5x10).

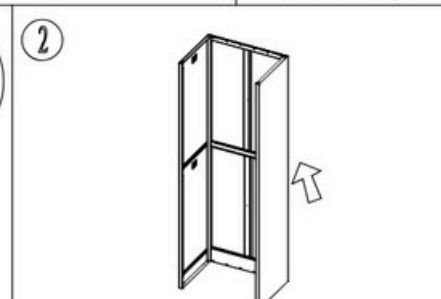

2 Pravou stranu přišroubujte k zadní desce stejným způsobem jako v prvním kroku.

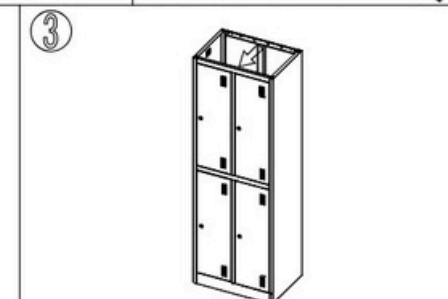

3 Upevněte zárubeň dveří do obou bočních desek.

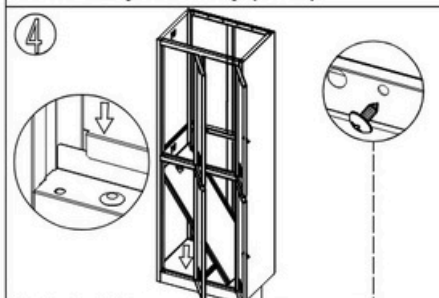

4 Nainstalujte spodní desku a poté stejným způsobem nainstalujte spodní dělicí desku.

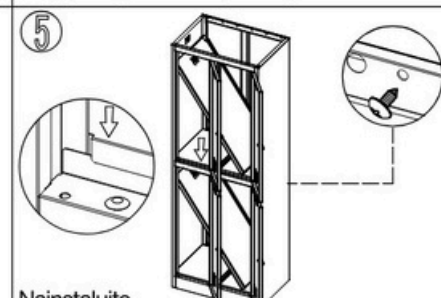

5 Nainstalujte středovou desku a poté podle výkresu nainstalujte horní dělicí desku.

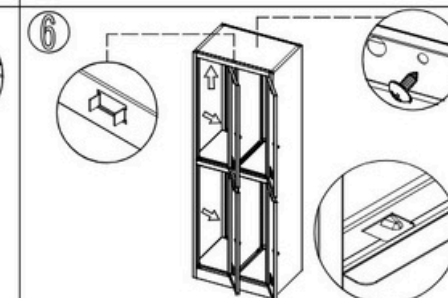

6 Nainstalujte horní desku a poté nastavte horní a dolní dělicí desku tak, aby dobře zapadly.



7 Nainstalujte věšákovou tyč podle označení.

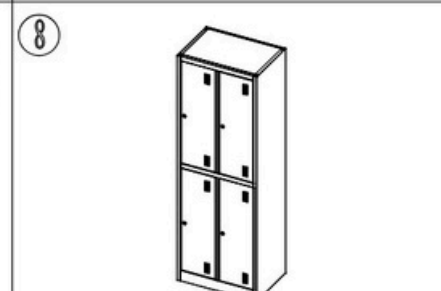

8 Po instalaci upravte každou část tak, aby dobře seděla.



Linke Seite: 1 Stk.



Rechte Seite: 1 Stk.

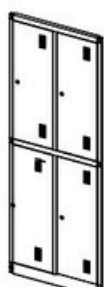

Türrahmen: 1 Stk.



Rückwand: 1 Stk.



Obere Platte: 1 Stk.



Mittlere Platte: 1 Stk.

Kleiderstange:
Links (kurz): 2 Stk.
Rechts (lang): 2 Stk.

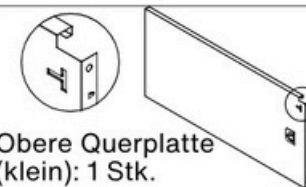

Obere Querplatte
(klein): 1 Stk.



Bodenplatte: 1 Stk.



Selbstschneidende
Schrauben (5x10): 16 Stk.



Schlüssel: 4 Sets

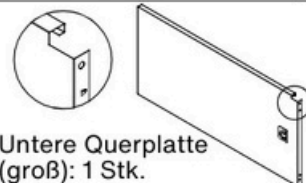

Untere Querplatte
(groß): 1 Stk.

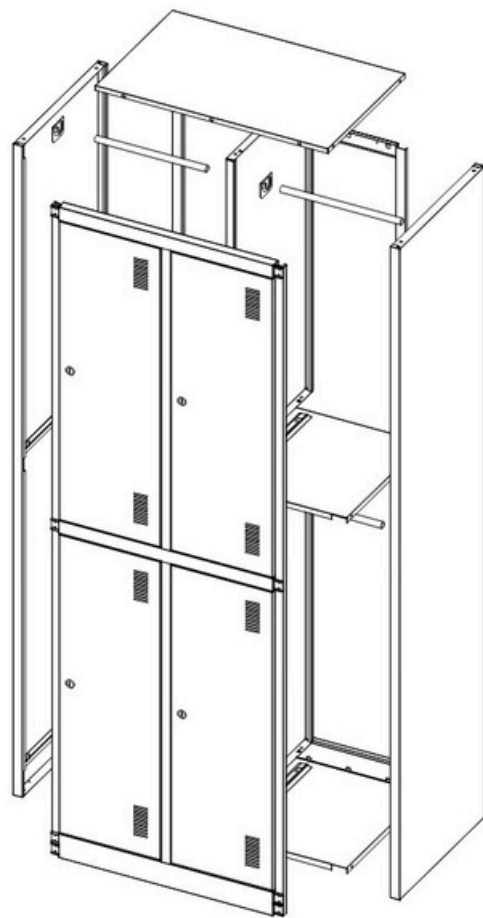

①

Schrauben Sie die linke Seite und die Rückwand mit selbstschneidenden Schrauben (5x10) zusammen.

②

Befestigen Sie die rechte Seite auf die gleiche Weise wie im ersten Schritt an der Rückwand.

③

Befestigen Sie den Türrahmen an beiden Seitenplatten.

④

Montieren Sie die Bodenplatte und danach auf die gleiche Weise die untere Trennplatte.

⑤

Montieren Sie die mittlere Platte und danach gemäß der Zeichnung die obere Trennplatte.

⑥

Montieren Sie die obere Platte und richten Sie anschließend die obere und untere Trennplatte so aus, dass sie gut sitzen.

⑦

Montieren Sie die Kleiderstange wie markiert.

⑧

Passen Sie nach der Montage alle Teile so an, dass sie gut sitzen.

DE



Left side: 1 pc



Right side: 1 pc

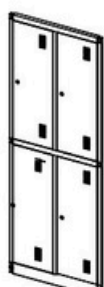

Door frame: 1 pc



Back plate: 1 pc



Top plate: 1 pc

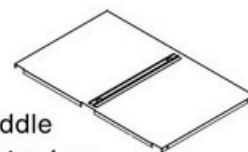

Middle plate: 1 pc



Hanging rod:
Left (short): 2 pc
Right (long): 2 pc

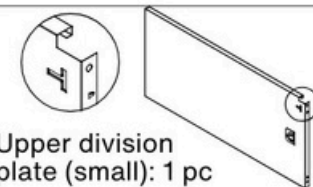

Upper division plate (small): 1 pc



Bottom plate: 1 pc



Self-tapping screw
(5x10): 16 pcs



Key: 4 sets

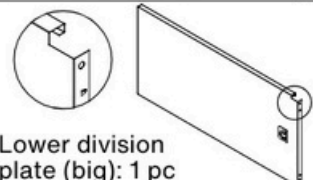

Lower division plate (big): 1 pc

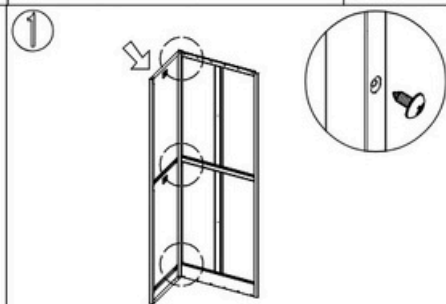
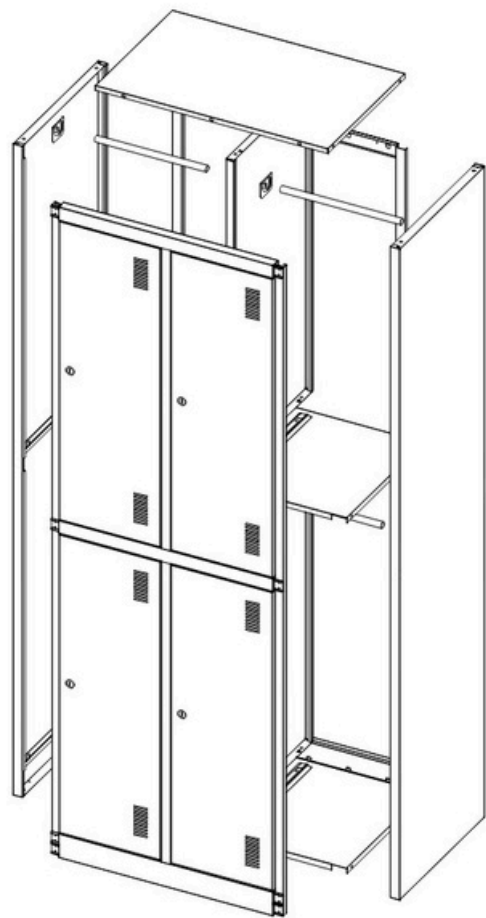

1 Bolt the left side and back plate with self-tapping screws (5x10).

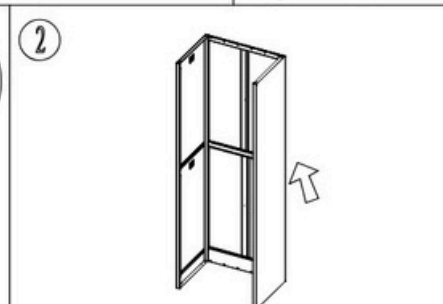

2 Bolt the right side with back plate in the same way as the first step.

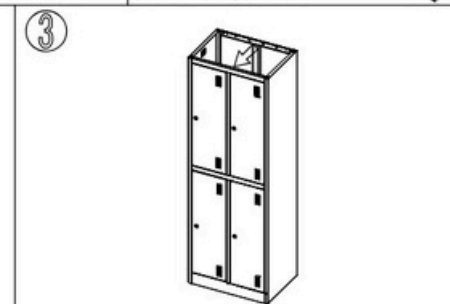

3 Fix the door frame onto both of the side plates.

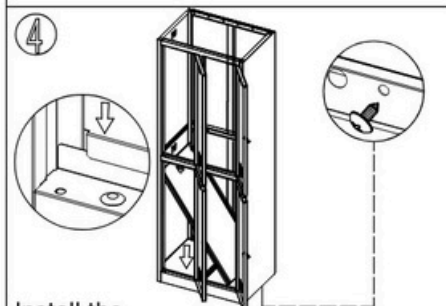

4 Install the bottom plate, then install the lower division plate in the same way.

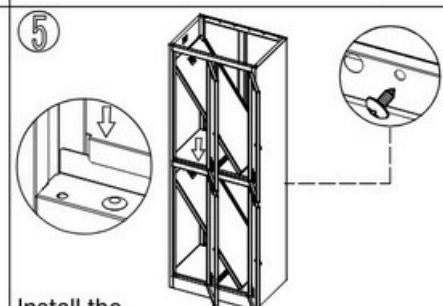

5 Install the middle plate, then install the upper division plate as the drawing.

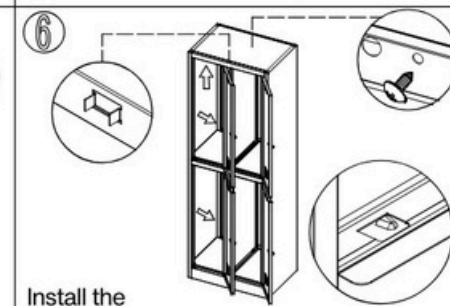

6 Install the top plate, then adjust the upper and lower division plate till fit well.

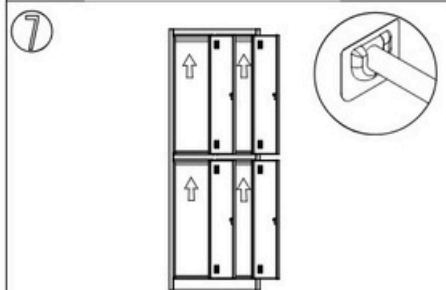

7 Install the hanging rod as the sign.

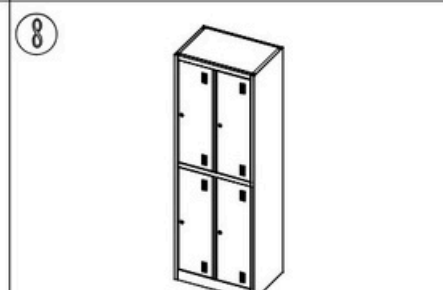

8 Adjust each part till fit well after installation.



Lewa strona: 1 szt.



Prawa strona: 1 szt.

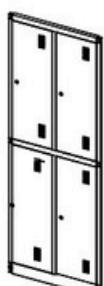

Rama drzwi: 1 szt.



Tylna płyta: 1 szt.

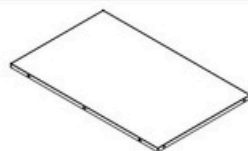

Górna płyta: 1 szt.



Płyta
środkowa: 1 szt.



Dolna płyta: 1 szt.

Drażek do
wieszania ubrań:
Lewy (krótki): 2 szt.
Prawy (długi): 2 szt.

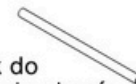

Wkręty samogwintujące
(5x10): 16 szt.



Klucze: 4 zestawy



Górna
płyta poprzeczna
(mała): 1 szt.

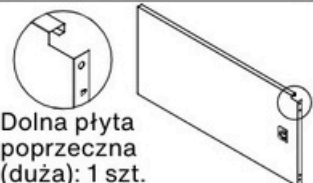

Dolna płyta
poprzeczna
(duża): 1 szt.

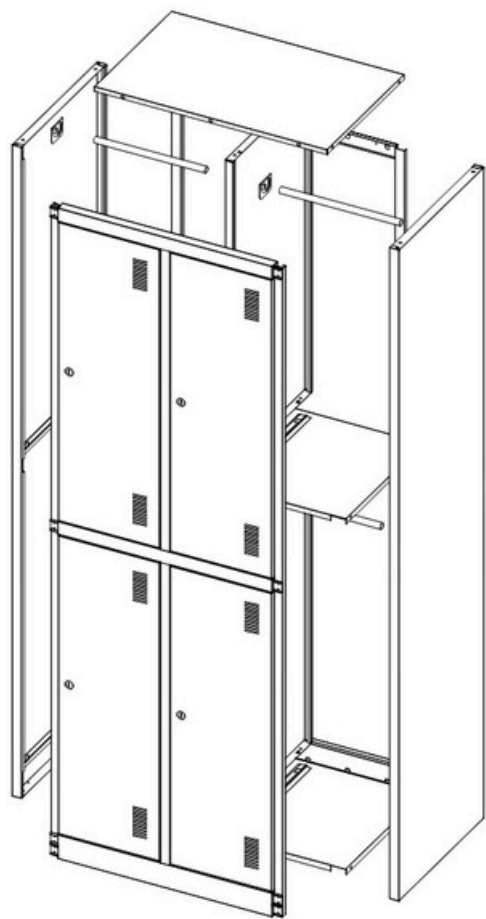

1 Przykręć lewą stronę i tylną płytę za pomocą wkrętów samogwintujących (5x10).

2 Przykręć prawą stronę do tylnej płyty w taki sam sposób jak w pierwszym kroku.

3 Przymocuj ościeżnicę drzwi do obu bocznych płyt.

4 Zamontuj dolną płytę, a następnie w ten sam sposób zamontuj dolną płytę dzielącą.

5 Zamontuj płytę środkową, a następnie zgodnie z rysunkiem zamontuj górną płytę dzielącą.

6 Zamontuj górną płytę, a następnie wyreguluj górną i dolną płytę dzielącą, aż będą dobrze dopasowane.

7 Zamontuj drążek zgodnie z oznaczeniem.

8 Po montażu wyreguluj każdą część, aby dobrze pasowała.

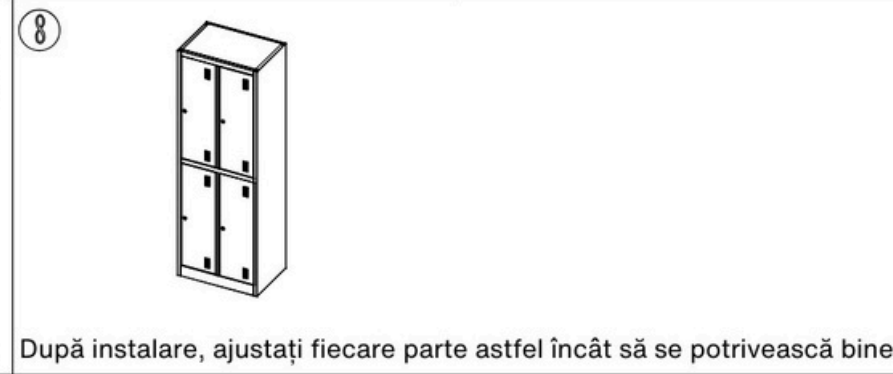
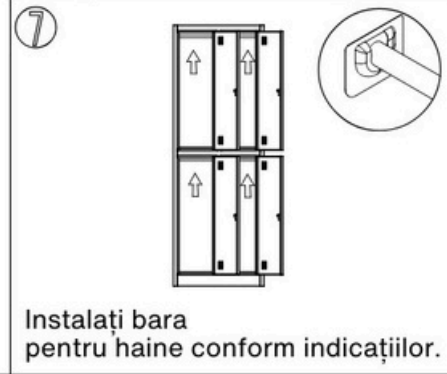
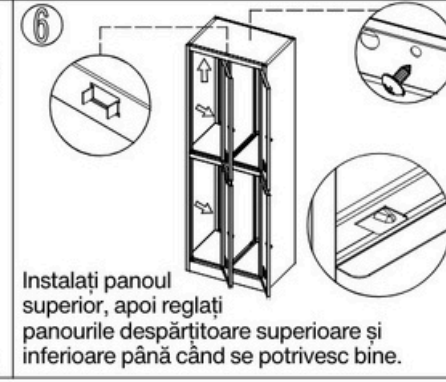
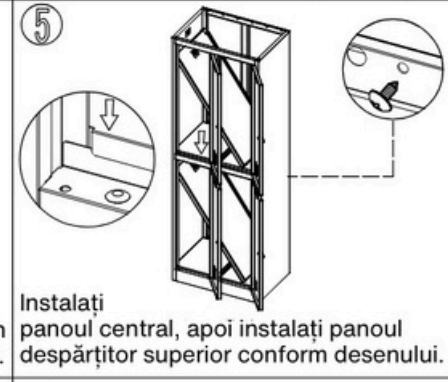
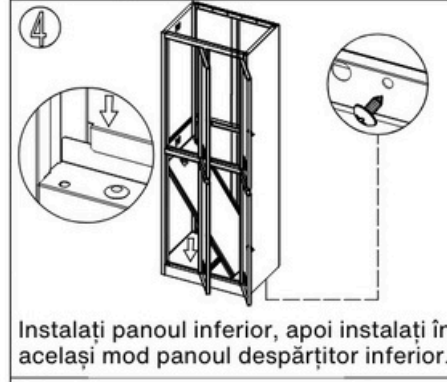
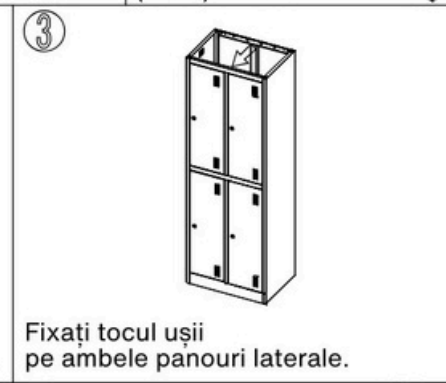
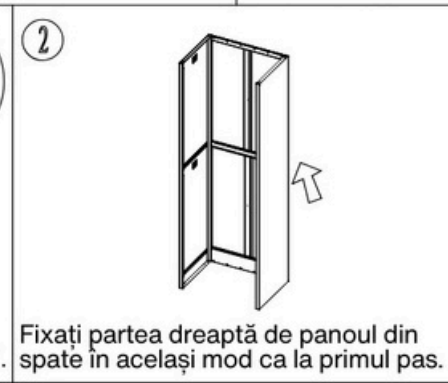
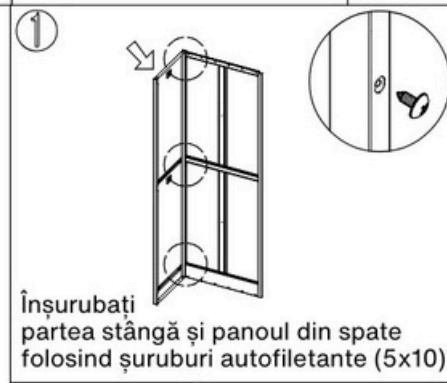
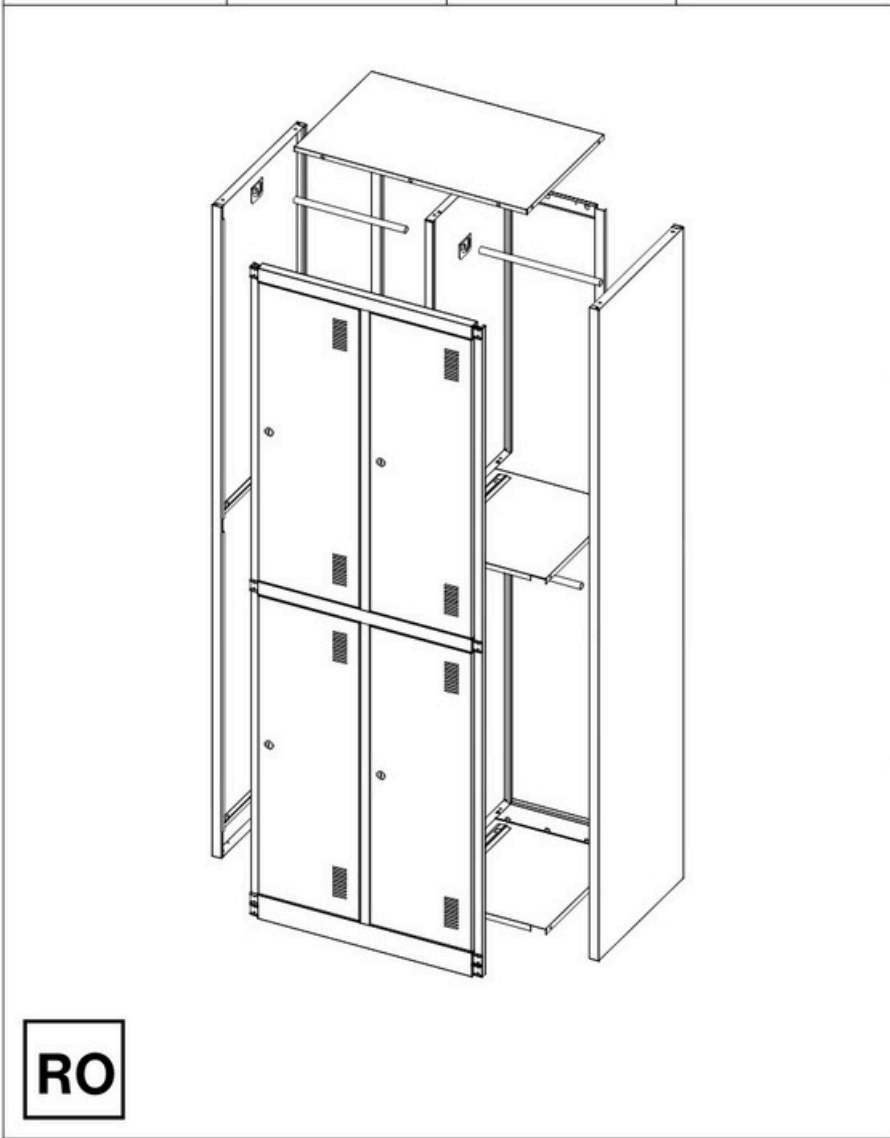
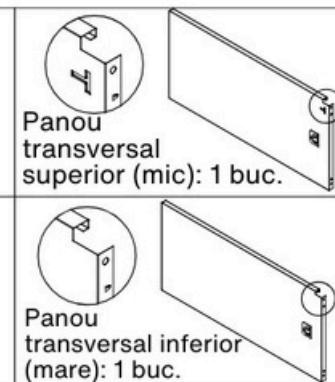
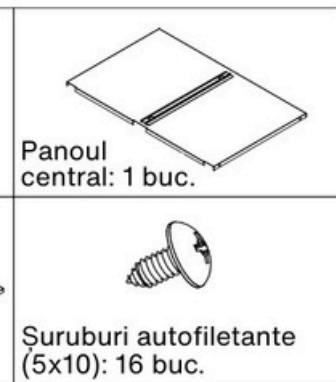
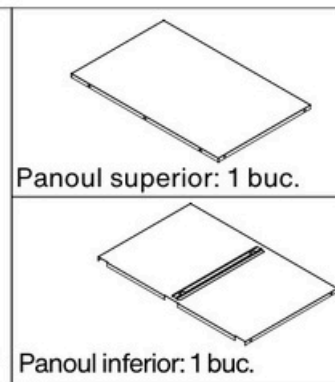
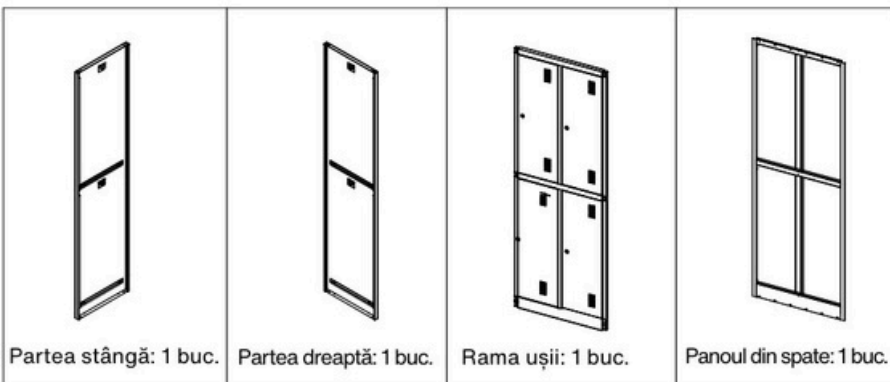



Lato sinistro: 1 pz



Lato destro: 1 pz

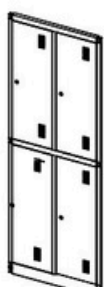

Telaio della porta: 1 pz



Pannello posteriore: 1 pz



Pannello superiore: 1 pz

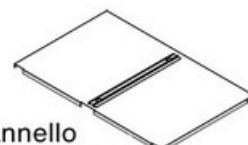

Pannello centrale: 1 pz

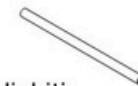

Barra appendiabiti:
Sinistra (corta): 2 pz
Destra (lunga): 2 pz

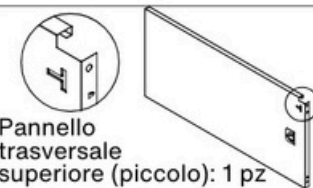

Pannello trasversale superiore (piccolo): 1 pz



Pannello inferiore: 1 pz



Viti autofilettanti (5x10): 16 pz



Chiavi: 4 set



Pannello trasversale inferiore (grande): 1 pz

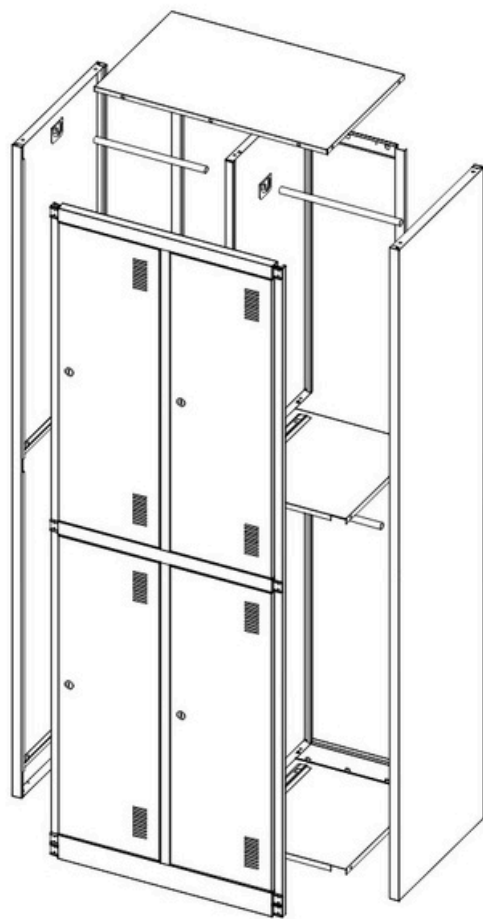

①

Avvitare il lato sinistro e il pannello posteriore utilizzando le viti autofilettanti (5x10).

②

Fissare il lato destro al pannello posteriore nello stesso modo del primo passaggio.

③

Fissare il telaio della porta a entrambi i pannelli laterali.

④

Installare il pannello inferiore e successivamente installare nello stesso modo il pannello divisorio inferiore.

⑤

Installare il pannello centrale e poi installare il pannello divisorio superiore secondo il disegno.

⑥

Installare il pannello superiore e quindi regolare i pannelli divisorii superiore e inferiore finché non si adattano correttamente.

⑦

Installare la barra appendiabiti come indicato.

⑧

Dopo l'installazione, regolare ogni parte in modo che si adatti correttamente.