

#26 MINI 8 FLAT F

1	SK	Montážny návod
2	CZ	Montážní návod
3	DE	Montageanleitung
4	ENG	Assembly instructions
5	PL	Instrukcja montażu
6	RO	Instrucțiuni de montaj
7	IT	Istruzioni di montaggio

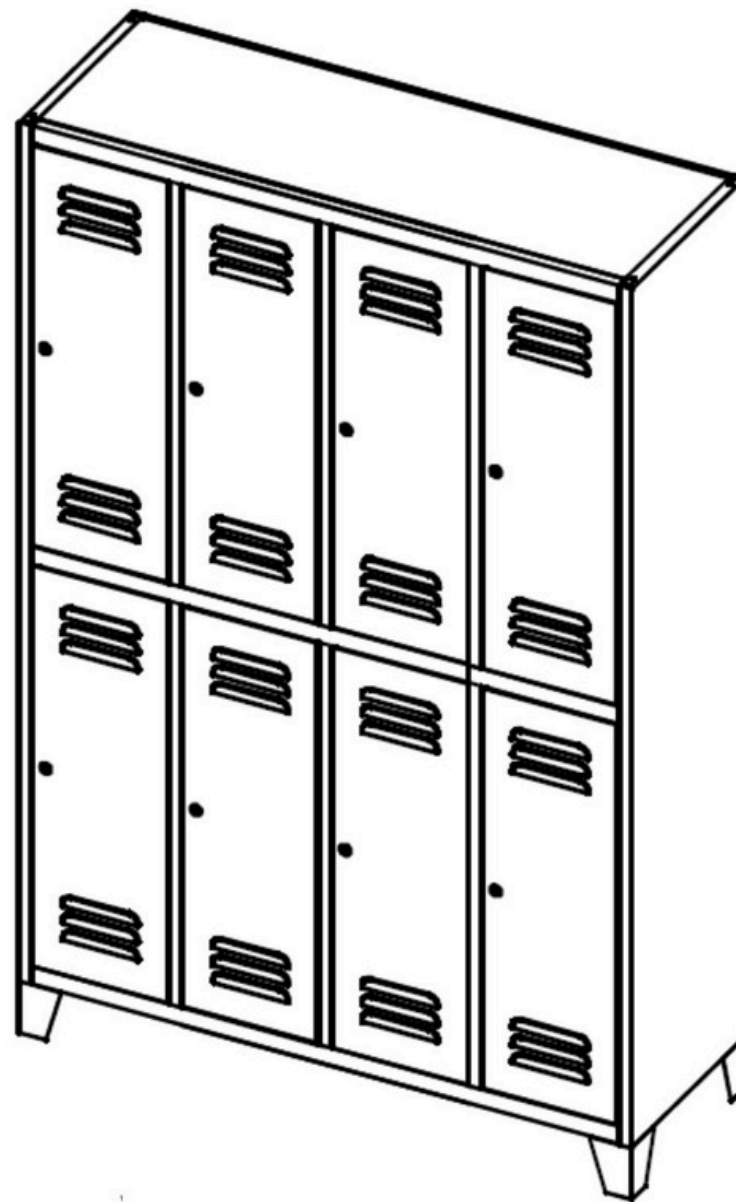



Lavá strana: 1 ks



Pravá strana: 1 ks



Rám dverí: 1 ks



Zadná doska: 1 ks

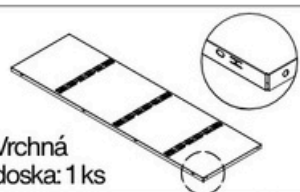

Vrchná doska: 1 ks

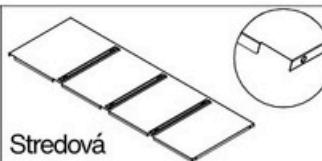

Stredová doska: 1 ks



Vešiaková tyč:
Ľavá (krátka) 6 ks
Pravá (dlhá) 2 ks



Kľúče: 8 setov



Horá priečna doska (malá): 3 ks



Spodná doska: 1 ks

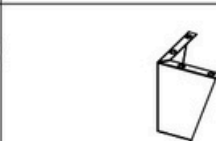

Nožičky: 4 ks



Samorezné skrutky
(5x10): 40 ks



Spodná priečna doska (veľká): 3 ks



Háčiky: 16 ks

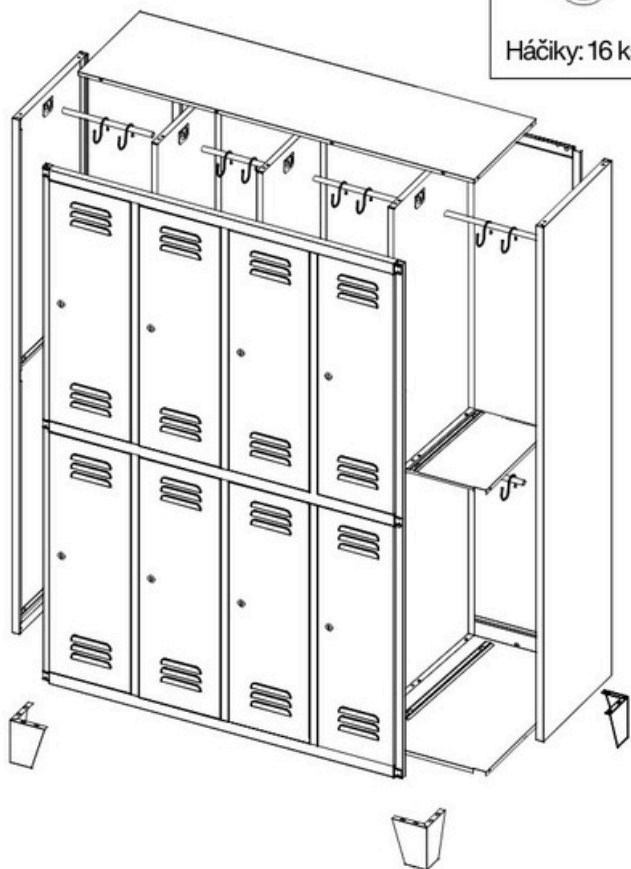

Priskrutkujte ľavú stranu a zadnú dosku samoreznými skrutkami (5x10)

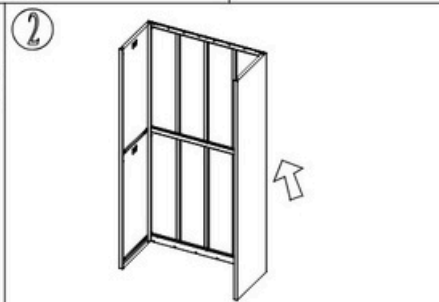

Pravú stranu priskrutkujte k zadnej doske rovnakým spôsobom ako v prvom kroku

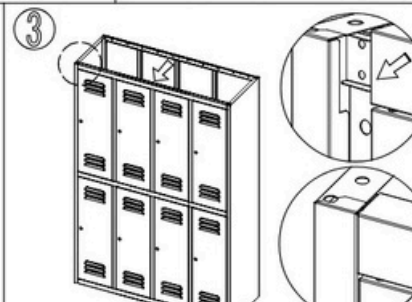

Upevnite zárubňu dverí na obe bočné dosky



Nainštalujte hornú a spodnú dosku

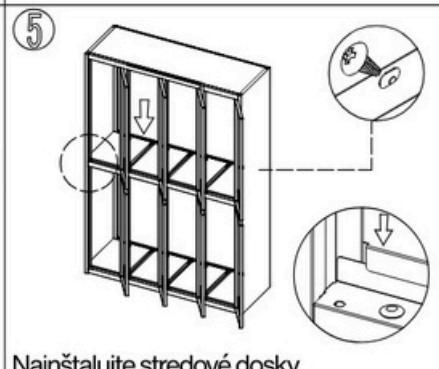

Nainštalujte stredové dosky.



Nainštalujte deliace dosky. (Venujte pozornosť rozdielu medzi hornými a dolnými, horná malá, dolná veľká.)

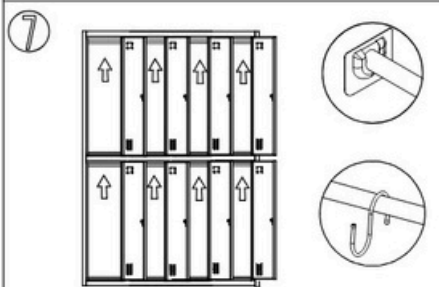

Nainštalujte vešiakovú tyč a háčiky.

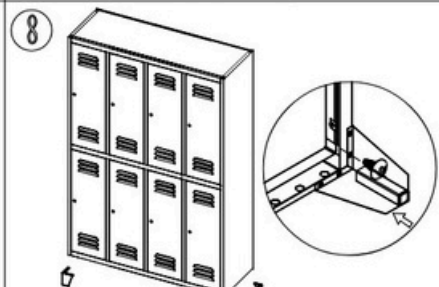

Nainštalujte nožičky so skrutkami (5x10).

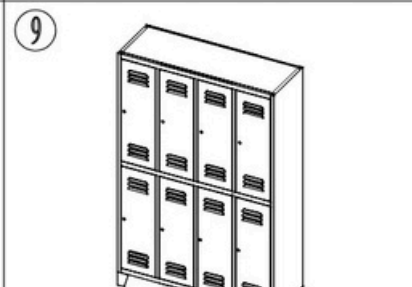

Po inštalácii upravte každú časť tak, aby dobre sedela.



Levá strana: 1 ks



Pravá strana: 1 ks



Rám dveří: 1 ks



Zadní deska: 1 ks

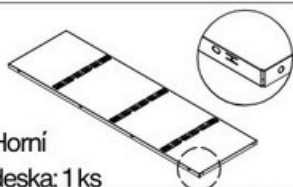

Horní deska: 1 ks

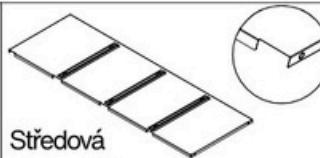

Středová deska: 1 ks



Věšáková tyč:
Levá (krátká): 6 ks
Pravá (dlouhá): 2 ks



Klíče: 8 sad



Horní příčná deska (malá): 3 ks



Spodní deska: 1 ks

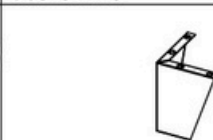

Nožičky: 4 ks



Samořezné šrouby
(5x10): 40 ks



Spodní příčná deska (velká): 3 ks



Háčky: 16 ks

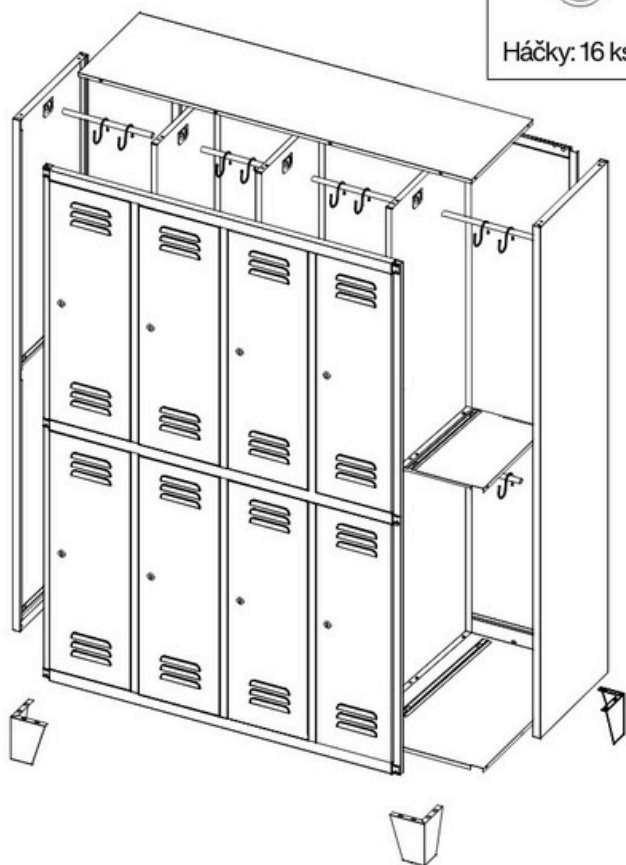

1 Přišroubujte levou stranu a zadní desku samořeznými šrouby (5x10).

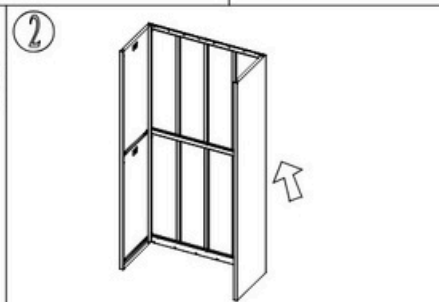

2 Pravou stranu přišroubujte k zadní desce stejným způsobem jako v prvním kroku.

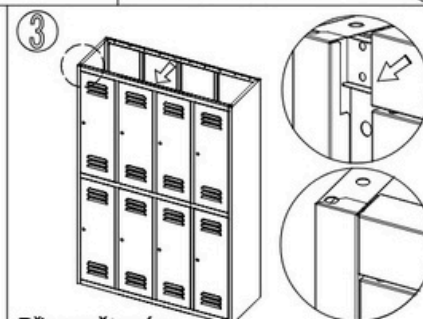

3 Připevněte rám dveří k oběma bočním deskám.

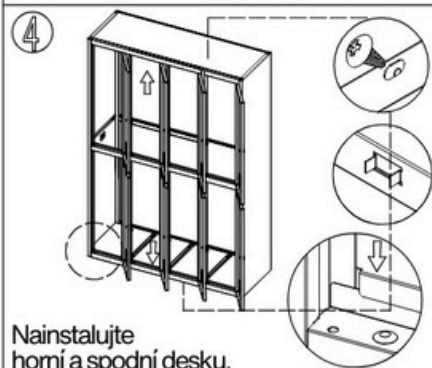

4 Nainstalujte horní a spodní desku.



5 Nainstalujte středové desky.



6 Nainstalujte dělicí desky. (Věnujte pozornost rozdílu mezi horními a dolními, horní jsou malé, dolní velké).

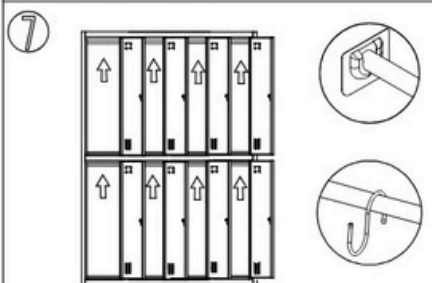

7 Nainstalujte věšákovou tyč a háčky.

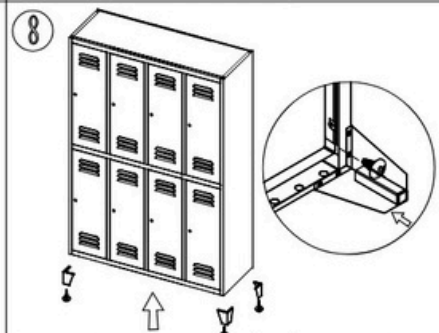

8 Nainstalujte nožičky pomocí šroubů (5x10).

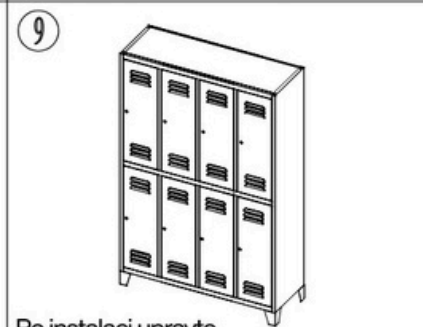

9 Po instalaci upravte každou část tak, aby dobře seděla.



Linke Seite: 1 Stk.



Rechte Seite: 1 Stk.



Türrahmen: 1 Stk.



Rückwand: 1 Stk.

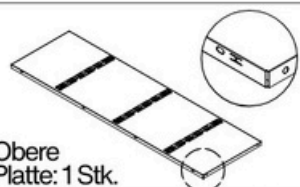

Obere
Platte: 1 Stk.

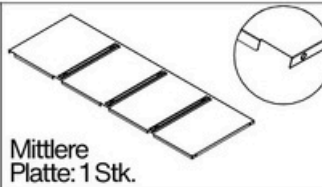

Mittlere
Platte: 1 Stk.



Kleiderstange:
Links (kurz): 6 Stk.
Rechts (lang): 2 Stk.

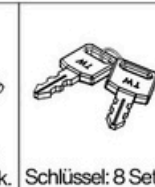

Schlüssel: 8 Sets

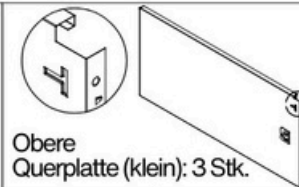

Obere
Querplatte (klein): 3 Stk.

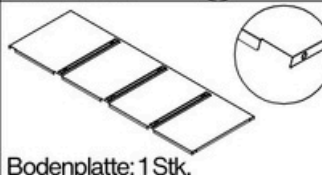

Bodenplatte: 1 Stk.



Füße: 4 Stk.



Selbstschneidende
Schrauben (5x10): 40 Stk.

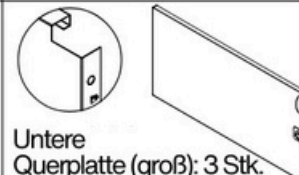

Untere
Querplatte (groß): 3 Stk.



Haken: 16 Stk.

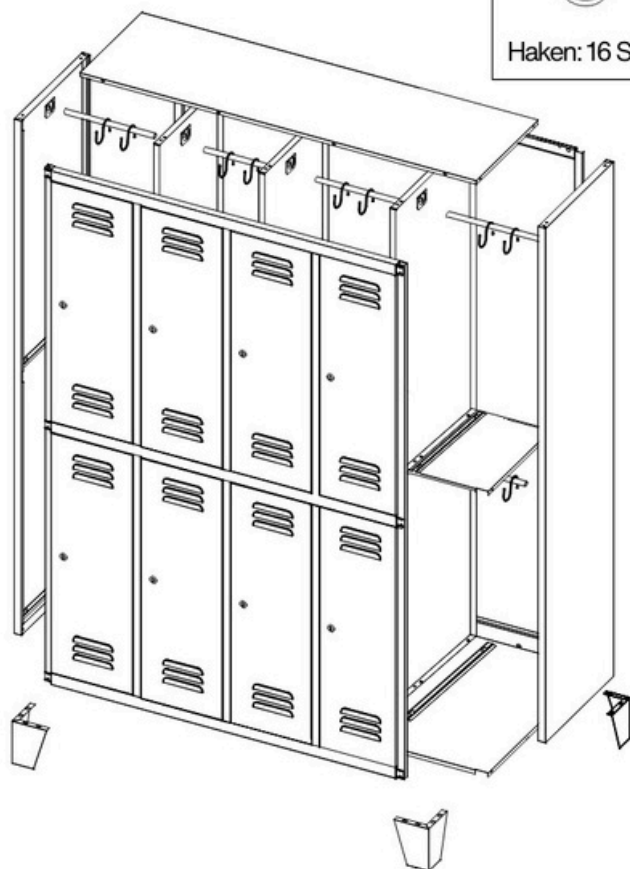

1 Schrauben Sie die linke Seite und die Rückwand mit selbstschneidenden Schrauben (5x10) zusammen.



2 Befestigen Sie die rechte Seite auf die gleiche Weise wie im ersten Schritt an der Rückwand.

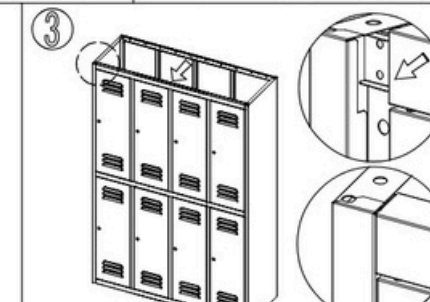

3 Befestigen Sie den Türrahmen an beiden Seitenplatten.

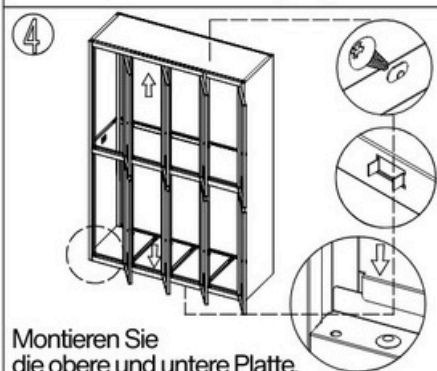

4 Montieren Sie die obere und untere Platte.



5 Montieren Sie die mittleren Platten.

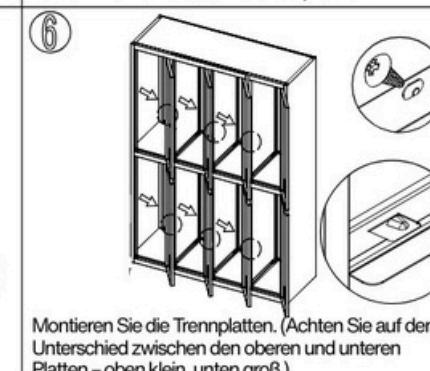

6 Montieren Sie die Trennplatten. (Achten Sie auf den Unterschied zwischen den oberen und unteren Platten – oben klein, unten groß.)

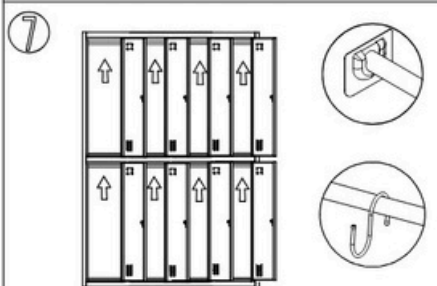

7 Montieren Sie die Kleiderstange und die Haken.

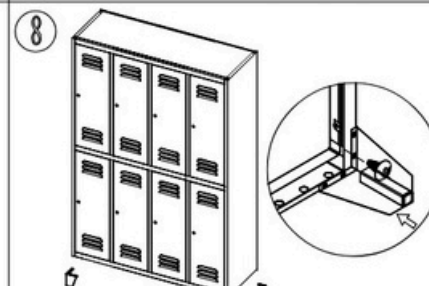

8 Montieren Sie die Füße mit Schrauben (5x10).

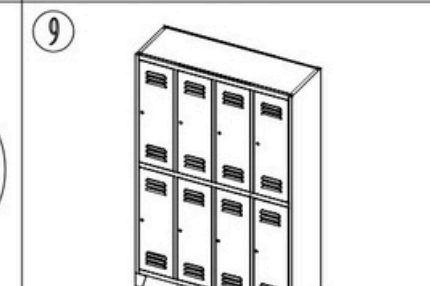

9 Passen Sie nach der Montage alle Teile so an, dass sie gut sitzen.



Left side : 1 pc



Right side : 1 pc



Door frame: 1 pc



Back plate: 1 pc

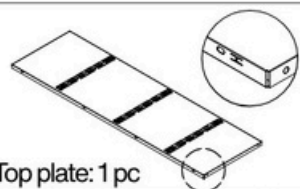

Top plate: 1 pc

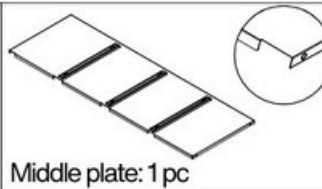

Middle plate: 1 pc

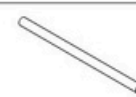

Hanging rod
Left (short): 6 pcs
Right (long): 2 pcs



Keys: 8 sets

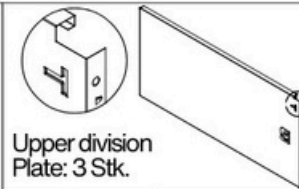

Upper division
Plate: 3 Stk.

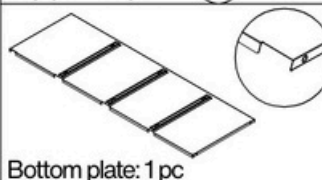

Bottom plate: 1 pc

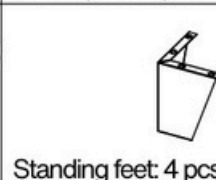

Standing feet: 4 pcs



Self-tapping screws (5x10):
40 pcs

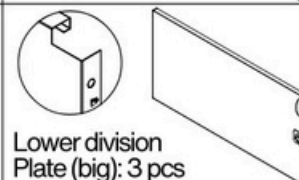

Lower division
Plate (big): 3 pcs



Hooks: 16 pcs

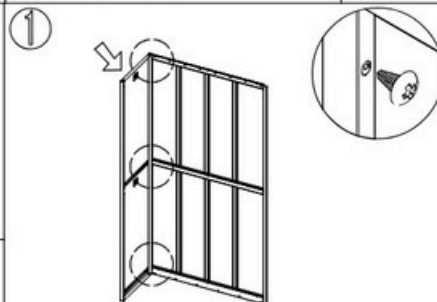
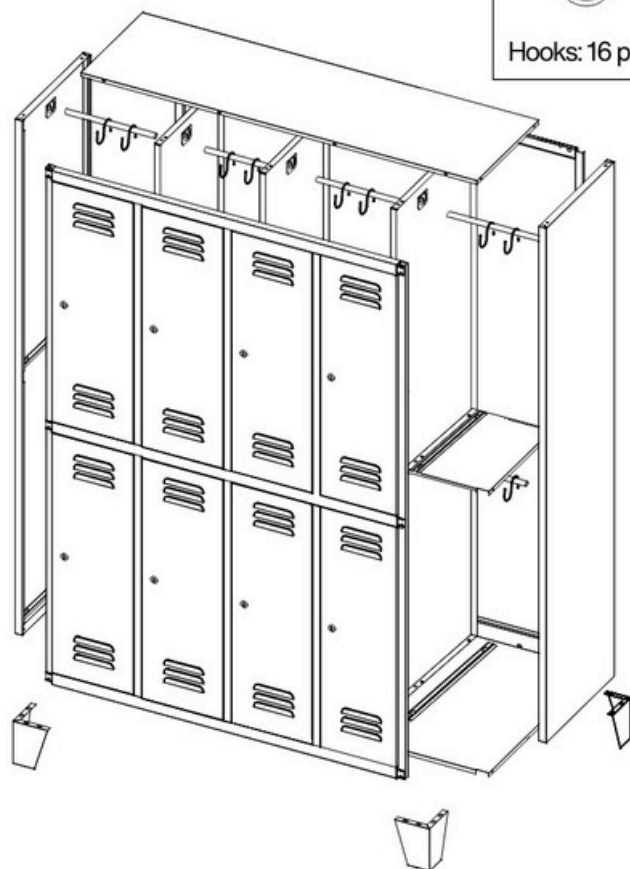

1 Bolt the left side and back plate with self-tapping screws (5x10).



2 Bolt the right side with back plate in the same way as the first step.

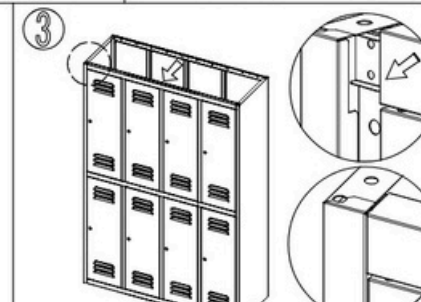

3 Fix the door frame into both of the side plates.

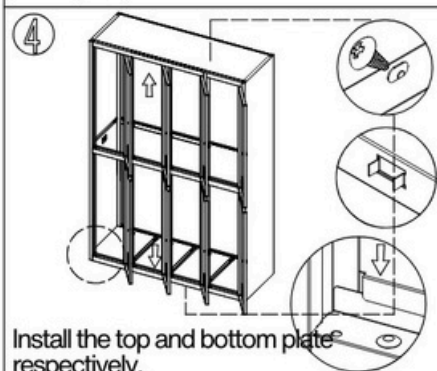

4 Install the top and bottom plate respectively.

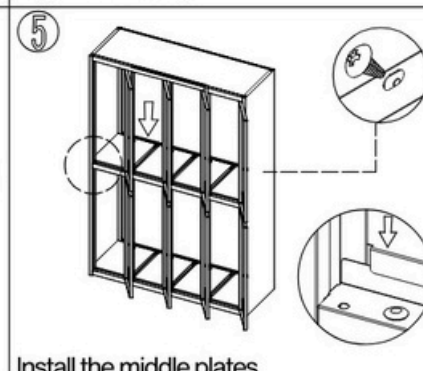

5 Install the middle plates.

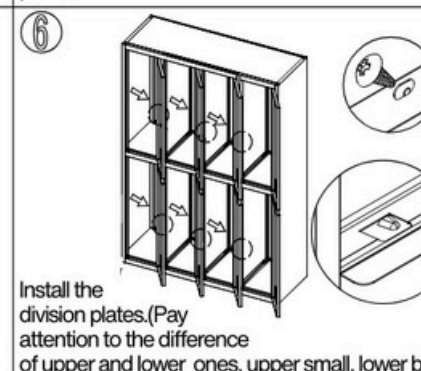

6 Install the division plates. (Pay attention to the difference of upper and lower ones, upper small, lower big).



7 Install the hanging rod and hook.

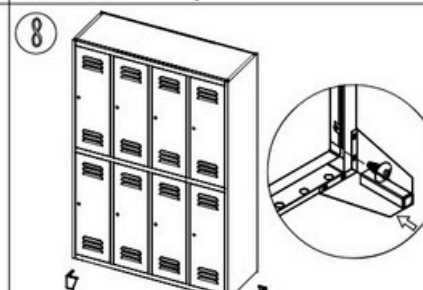

8 Install the standing feet with screws (5x10).

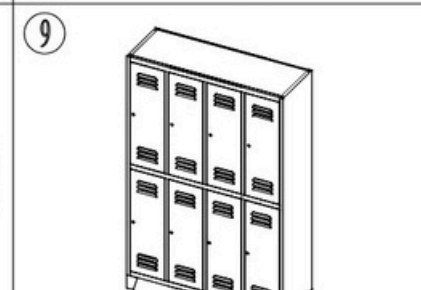

9 Adjust each part till fit well after installation.



Lewa strona: 1 szt.



Prawa strona: 1 szt.



Rama drzwi: 1 szt.

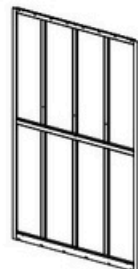

Tylna płyta: 1 szt.

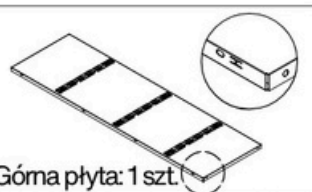

Górną płytę: 1 szt.

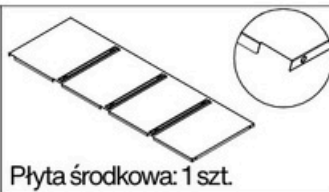

Płytę środkową: 1 szt.

Drażek do wieszania ubrań:
Lewy (krótki): 6 szt.
Prawy (długi): 2 szt.



Klucze:
8 zestawów

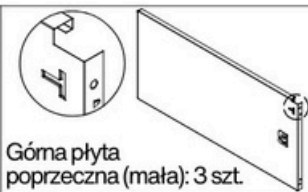

Górną płytę poprzeczną (małą): 3 szt.

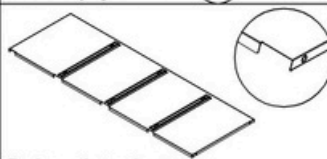

Dolną płytę: 1 szt.

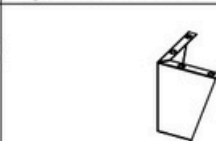

Nóżki: 4 szt.

Wkręty samogwintujące
(5x10): 40 szt.

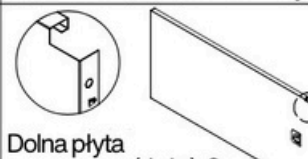

Dolną płytę poprzeczną (dużą): 3 szt.



Haczyki: 16 szt.

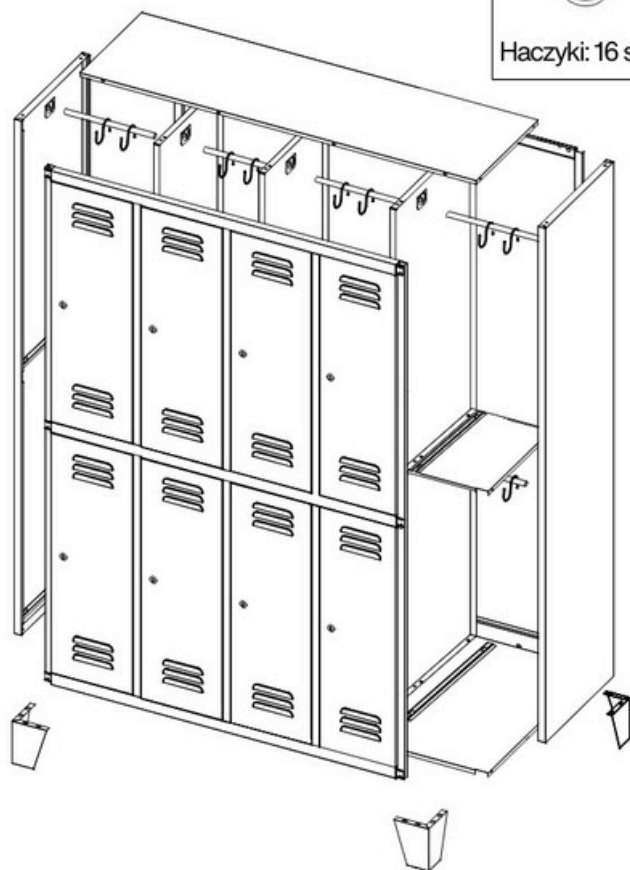

1 Przykręć lewą stronę i tylną płytę za pomocą wkrętów samogwintujących (5x10).

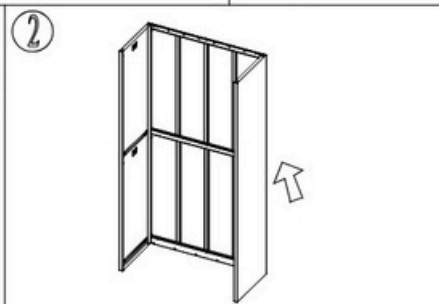

2 Przykręć prawą stronę do tylnej płyty w taki sam sposób jak w pierwszym kroku.

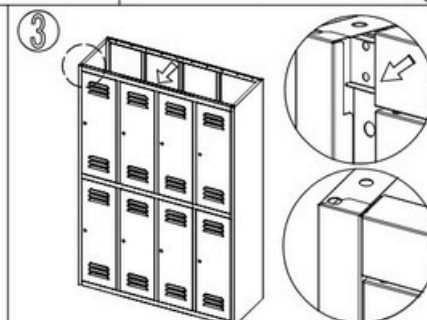

3 Przymocuj ramę drzwi do obu bocznych płyt.

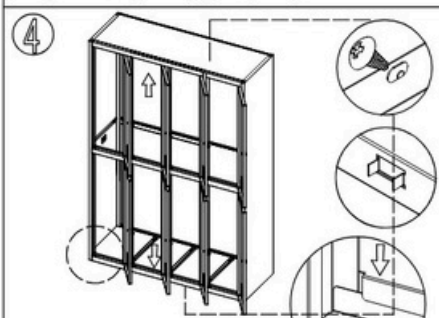

4 Zamontuj górną i dolną płytę.

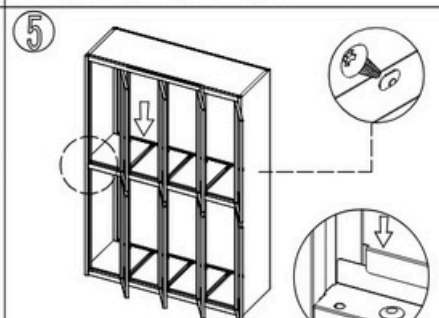

5 Zamontuj płyty środkowe.

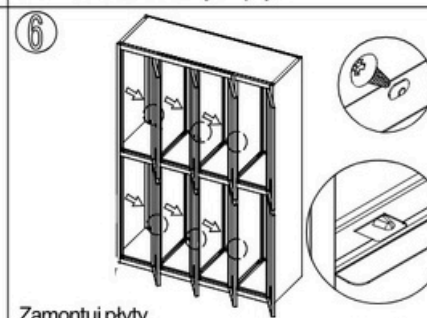

6 Zamontuj płyty dzielące. (Zwróć uwagę na różnicę między górnymi i dolnymi płytami – górne są małe, dolne duże.)

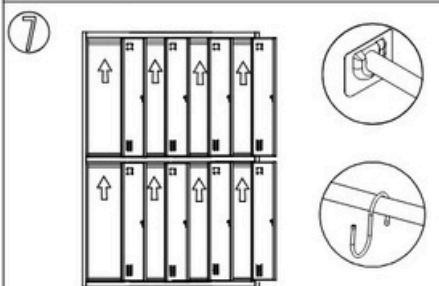

7 Zamontuj drążek do wieszania ubrań i haczyki.

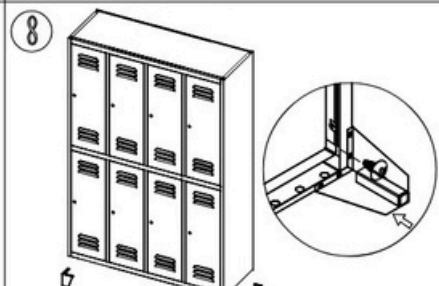

8 Zamontuj nóżki za pomocą wkrętów (5x10).

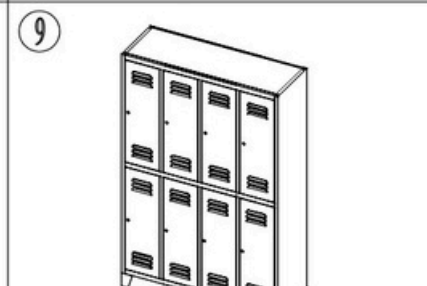

9 Po montażu wyreguluj każdą część, aby dobrze pasowała.



Partea stângă: 1 buc.



Partea dreaptă: 1 buc.



Rama uşii: 1 buc.



Panoul din spate:
1 buc.

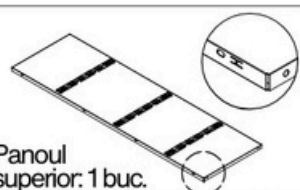

Panoul superior: 1 buc.



Panoul central: 1 buc.

Bară pentru agăţarea
hainelor:
Stânga (scurtă): 6 buc.
Dreapta (lungă): 2 buc.



Chei: 8 seturi

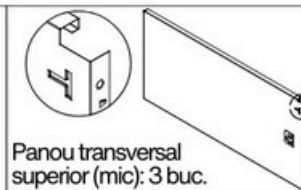

Panou transversal superior (mic): 3 buc.

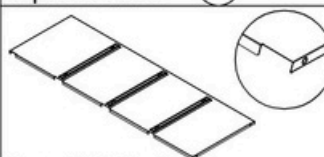

Panoul inferior: 1 buc.



Picioare: 4 buc.

Suruburi autofiletante
(5x10): 40 buc.

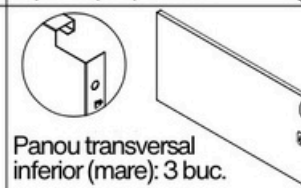

Panou transversal inferior (mare): 3 buc.



Cârliţe: 16 buc.

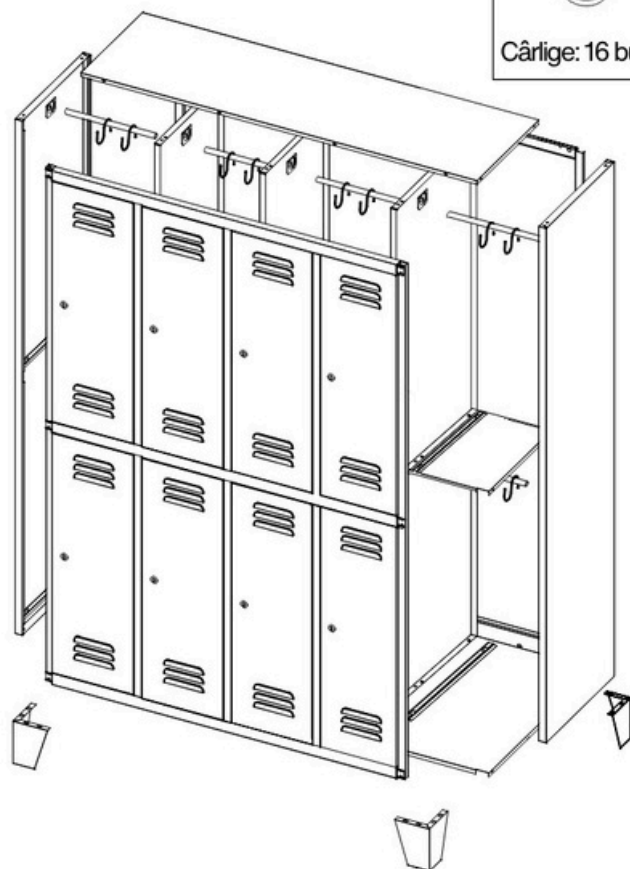

1 Înşurubaţi partea stângă şi panoul din spate folosind şuruburi autofiletante (5x10).

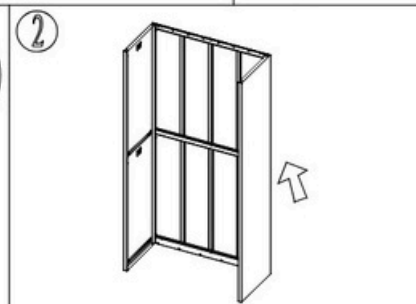

2 Fixaţi partea dreaptă de panoul din spate în acelaşi mod ca la primul pas.

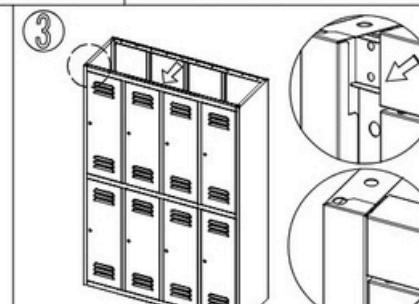

3 Fixaţi rama uşii pe ambele panouri laterale.



4 Instalaţi panoul superior şi panoul inferior.

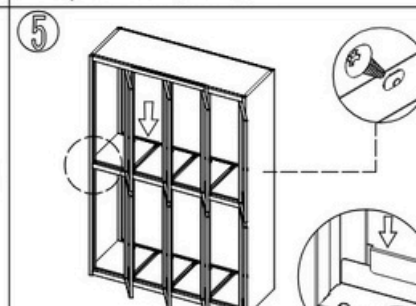

5 Instalaţi panourile centrale.

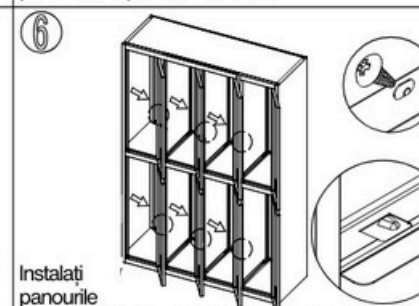

6 Instalaţi panourile despărţitoare. (Acordaţi atenţie diferenţei dintre cele superioare şi cele inferioare – cele superioare sunt mici, cele inferioare sunt mari.)

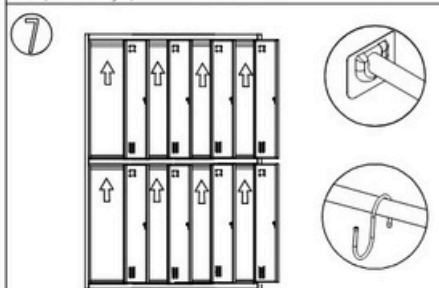

7 Instalaţi bara pentru agăţarea hainelor şi cârliţele.

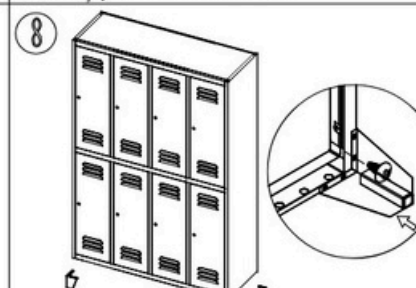

8 Instalaţi picioarele folosind şuruburi (5x10).

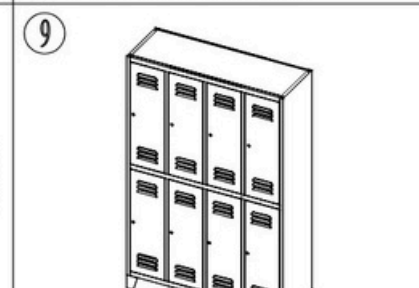

9 După instalare, ajustaţi fiecare parte astfel încât să se potrivească bine.

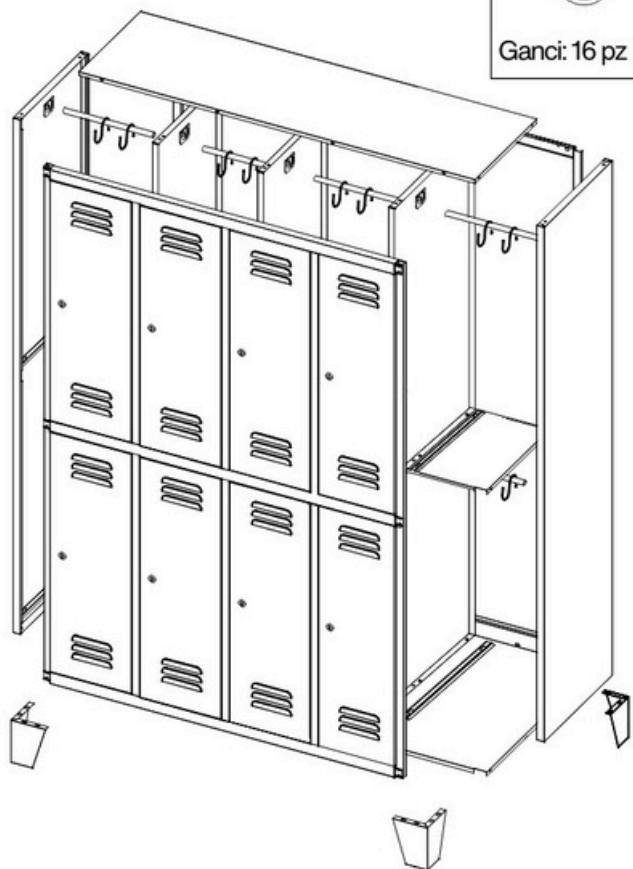
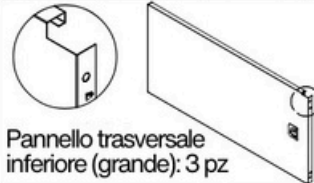
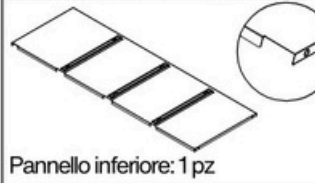
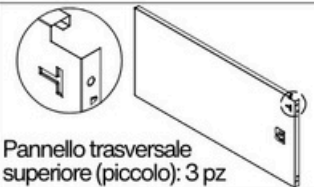
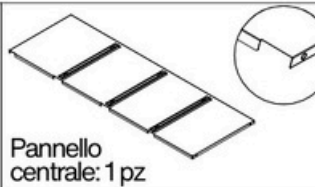
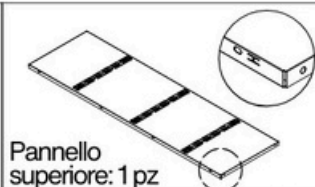

Avvitare il lato sinistro e il pannello posteriore utilizzando le viti autofilettanti (5x10).

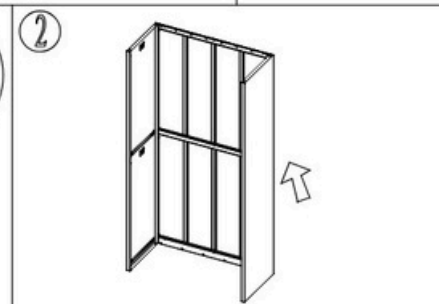

Fissare il lato destro al pannello posteriore nello stesso modo del primo passaggio.

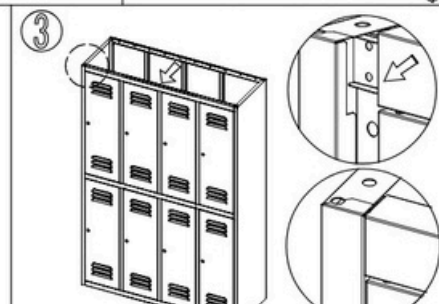

Fissare il telaio della porta a entrambi i pannelli laterali.



Installare il pannello superiore e quello inferiore.

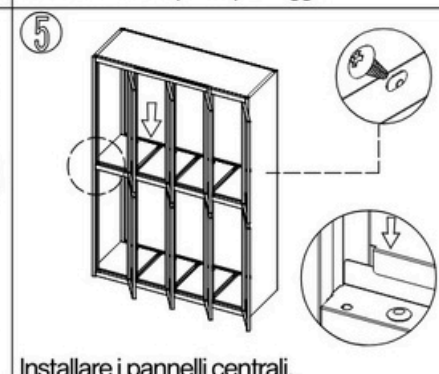

Installare i pannelli centrali.

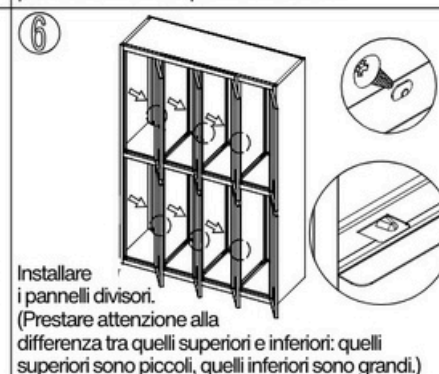

Installare i pannelli divisorii. (Prestare attenzione alla differenza tra quelli superiori e inferiori: quelli superiori sono piccoli, quelli inferiori sono grandi.)

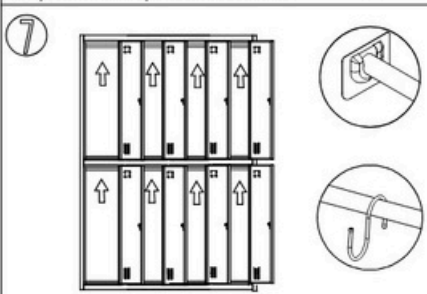

Installare la barra appendiabiti e i ganci.

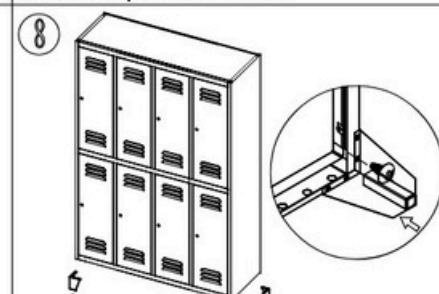

Installare i piedini con le viti (5x10).

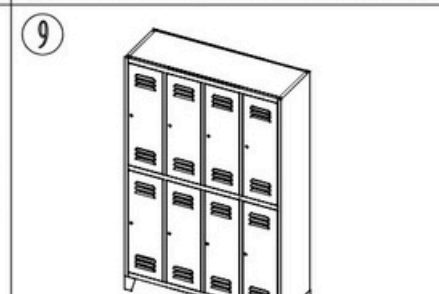

Dopo l'installazione, regolare ogni parte in modo che si adatti correttamente.