

#26 STANDARD 4 FLAT F

1	SK	Montážny návod
2	CZ	Montážní návod
3	DE	Montageanleitung
4	ENG	Assembly instructions
5	PL	Instrukcja montażu
6	RO	Instrucțiuni de montaj
7	IT	Istruzioni di montaggio

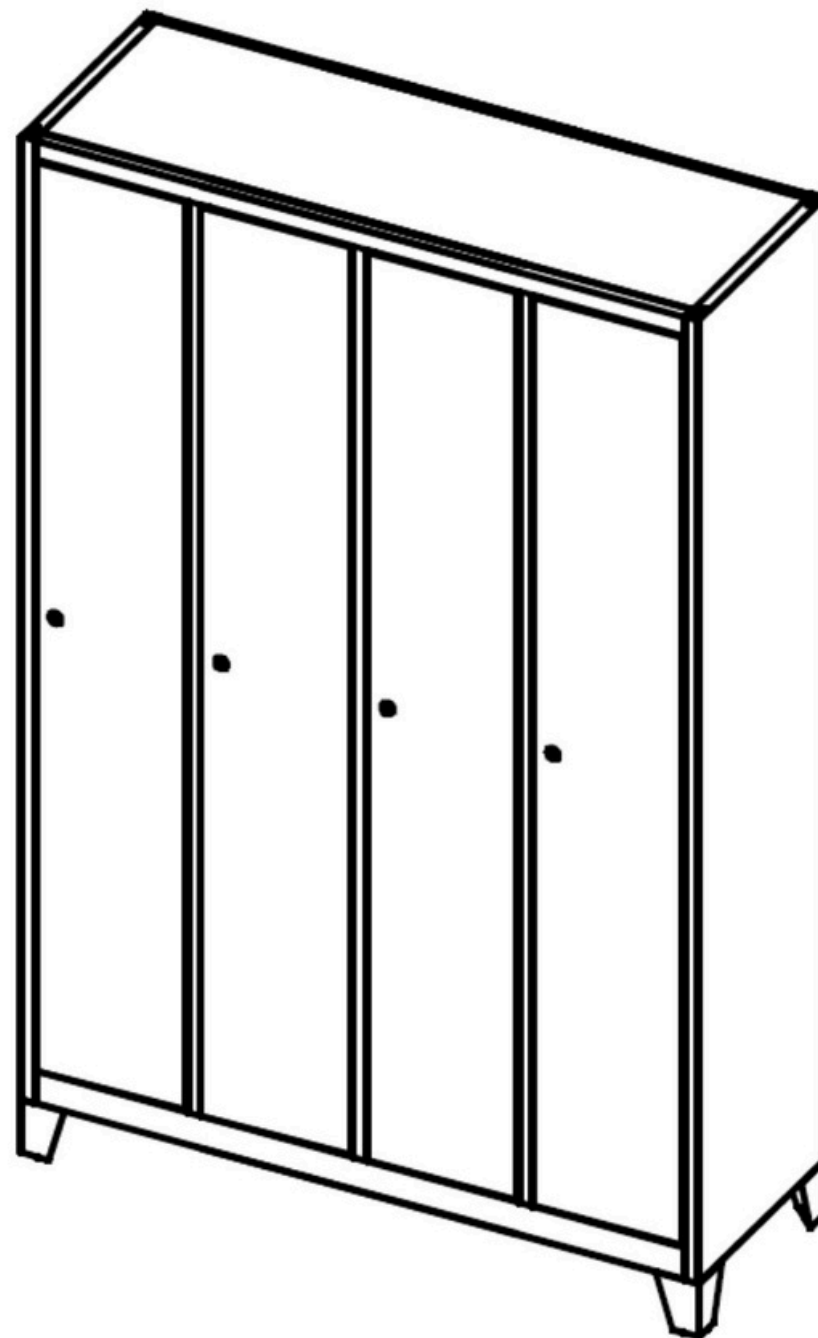



Lavá strana: 1 ks



Pravá strana: 1 ks

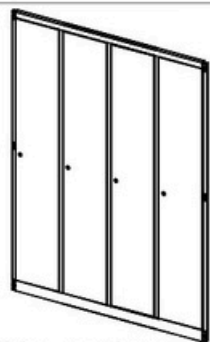

Rám dverí: 1 ks

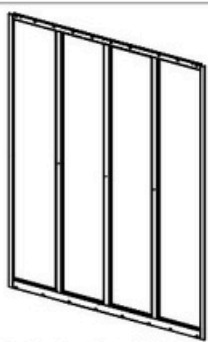

Zadná doska: 1 ks



Deliaca priečka: 3 ks

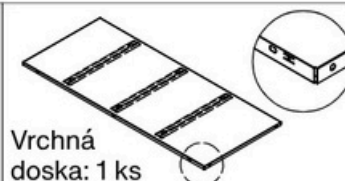

Vrchná doska: 1 ks

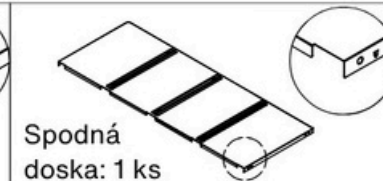

Spodná doska: 1 ks

Malé police:
Lavá (malá): 3 ks
Pravá (veľká): 1 ks



Samorezné skrutky (5x10): 50 ks



Nožičky: 4 ks



Klíúče: 4 sety

Vešiaková tyč:
Lavá (krátka): 3 ks
Pravá (dlhá): 1 ks



Háčiky: 8 ks

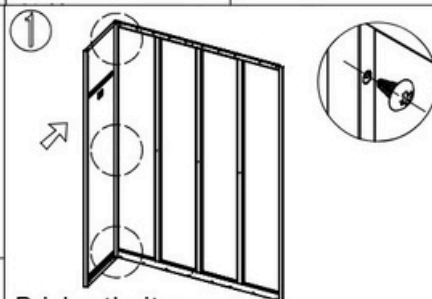
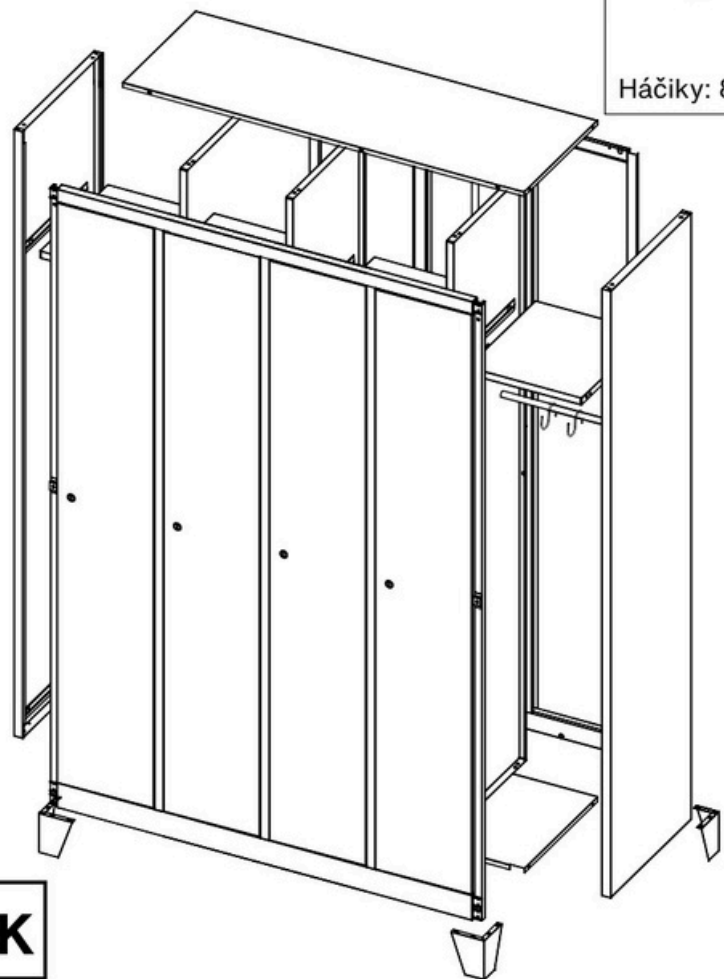

1 Priskrutkujte ľavú stranu a zadnú dosku samoreznými skrutkami (5x10)

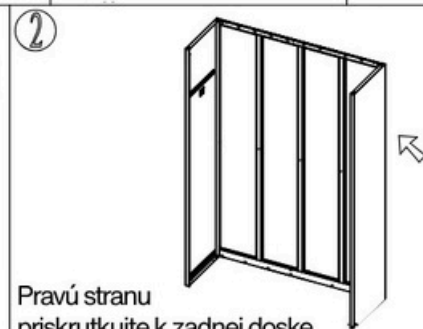

2 Pravú stranu priskrutkujte k zadnej doske rovnakým spôsobom ako v prvom kroku

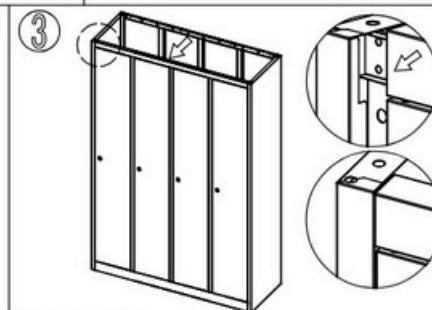

3 Pripevnite zárubňu dverí na obe bočné dosky

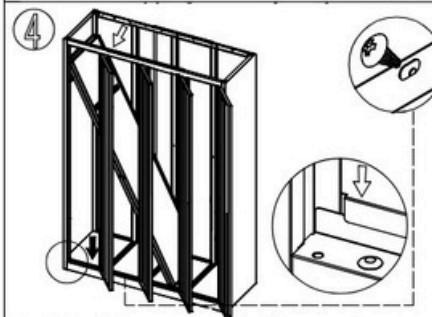

4 Nainštalujte spodnú dosku a potom upevnite deliacu dosku ako je označené

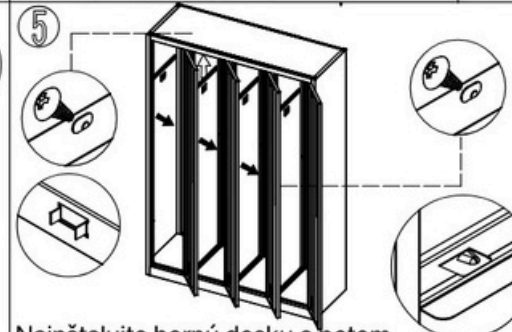

5 Nainštalujte hornú dosku a potom upevnite deliacu dosku ako je označené

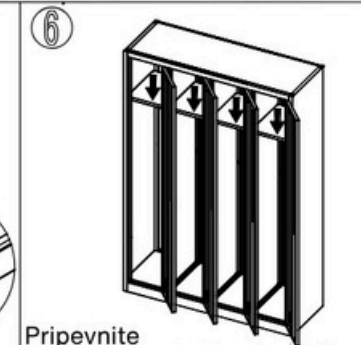

6 Pripevnite malé police tak ako sú označené.

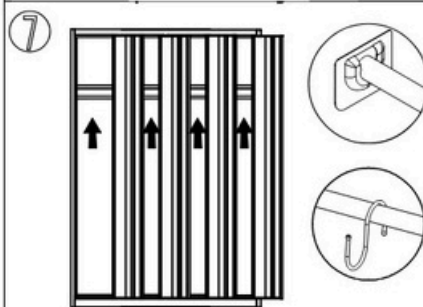

7 Nainštalujte vešiakovú tyč a háčiky.

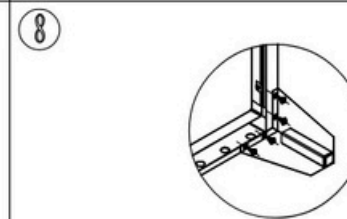

8 Nainštalujte nožičky pomocou skrutiek (5x10). Po inštalácii upravte každú časť tak, aby dobre sedela.

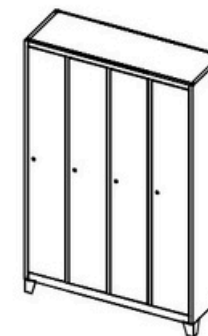

SK



Levá strana: 1 ks



Pravá strana: 1 ks

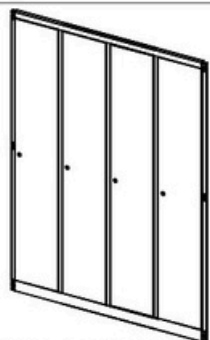

Rám dveří: 1 ks

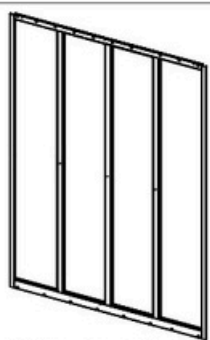

Zadní deska: 1 ks



Dělicí příčka: 3 ks

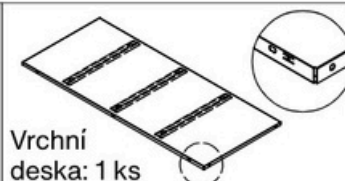

Vrchní deska: 1 ks

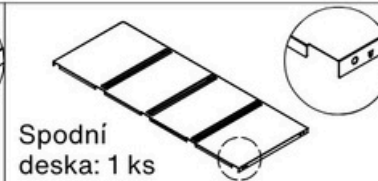

Spodní deska: 1 ks

Malé police:
Levá (malá): 3 ks
Pravá (velká): 1 ks



Samořezné šrouby
(5x10): 50 ks



Nožičky: 4 ks



Klíče: 4 sady

Věšáková tyč:
Levá (krátká): 3 ks
Pravá (dlouhá): 1 ks



Háčky: 8 ks

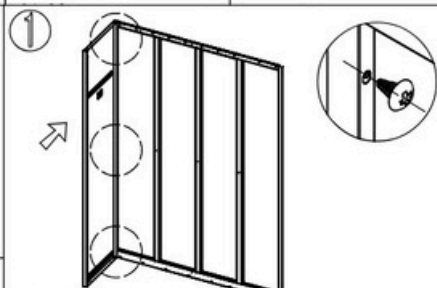
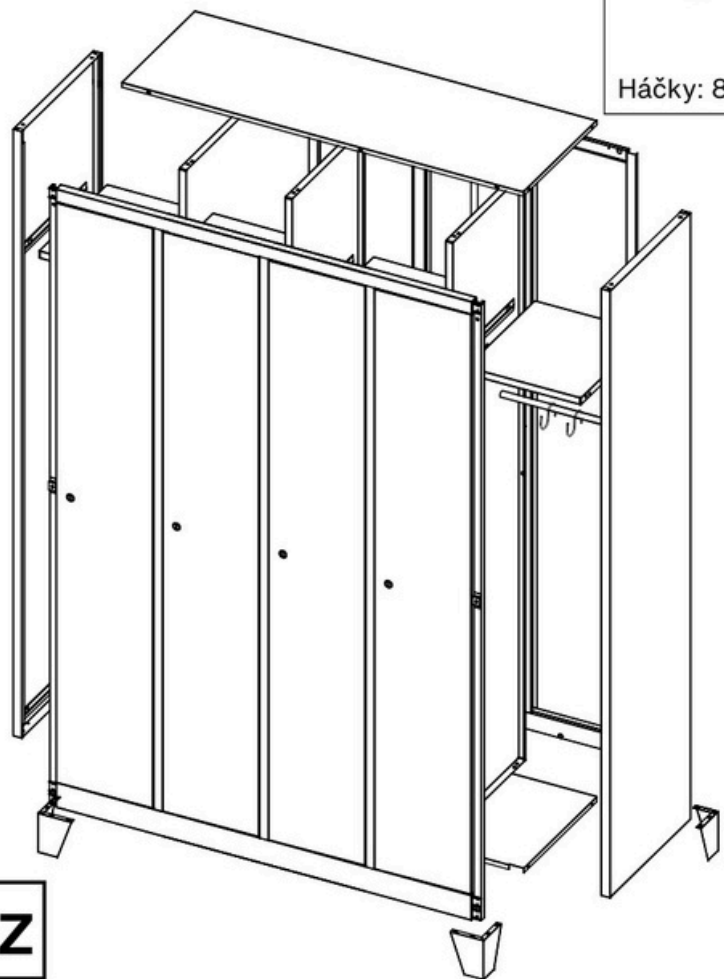

1 Přišroubujte levou stranu a zadní desku samořeznými šrouby (5x10).

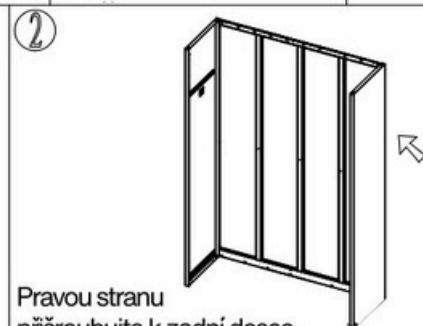

2 Pravou stranu přišroubujte k zadní desce stejným způsobem jako v prvním kroku.

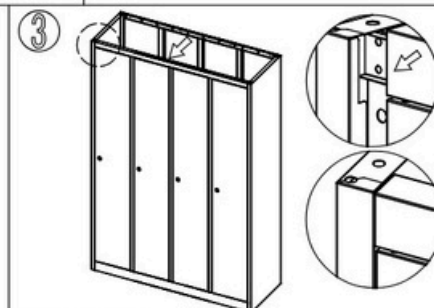

3 Připevněte zárubeň dveří na obě boční desky.

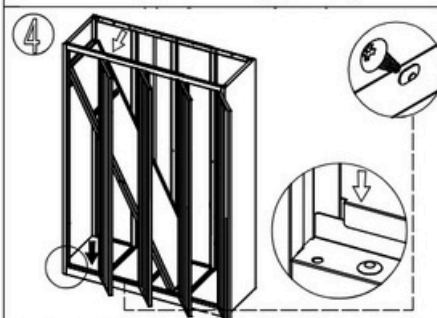

4 Nainstalujte spodní desku a poté upevněte dělicí desku podle označení.

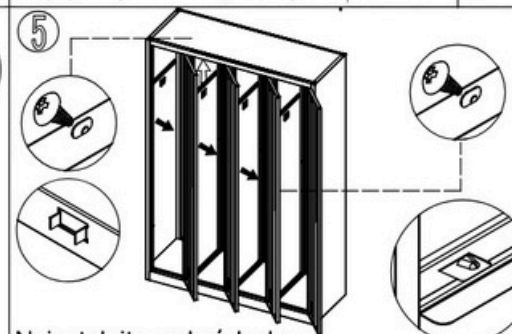

5 Nainstalujte vrchní desku a poté upevněte dělicí desku podle označení.

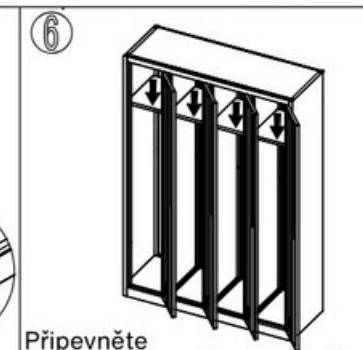

6 Připevněte malé police podle označení.

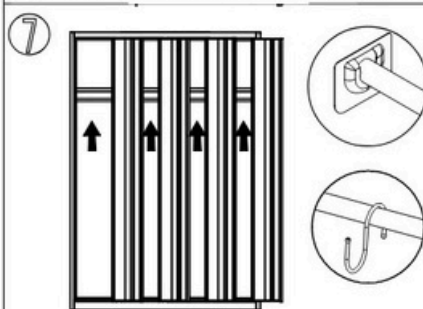

7 Nainstalujte věšákovou tyč a háčky.

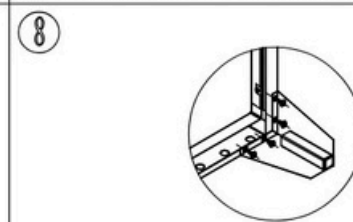

8 Nainstalujte nožičky pomocí šroubů (5x10). Po instalaci upravte každou část tak, aby dobře seděla.



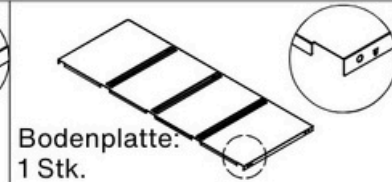
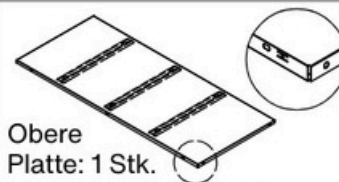
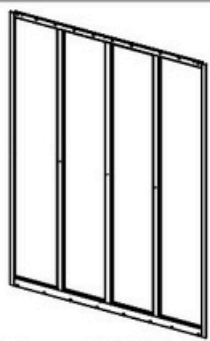
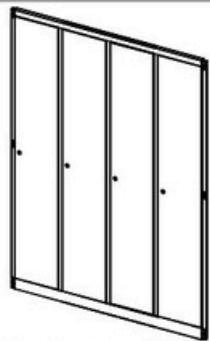
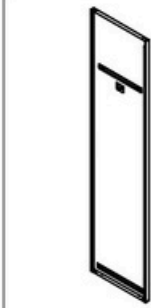

Linke Seite: 1 Stk.

Rechte Seite: 1 Stk.

Türrahmen: 1 Stk.

Rückwand: 1 Stk.

Trennwand: 3 Stk.

Obere
Platte: 1 Stk.

Bodenplatte:
1 Stk.

Kleine
Regalböden:
Links (klein): 3 Stk.
Rechts (groß): 1 Stk.

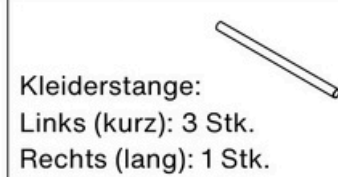

Selbstschneidende
Schrauben (5x10):
50 Stk.

Standfüße: 4 Stk.

Schlüssel:
4 Sets

Kleiderstange:
Links (kurz): 3 Stk.
Rechts (lang): 1 Stk.

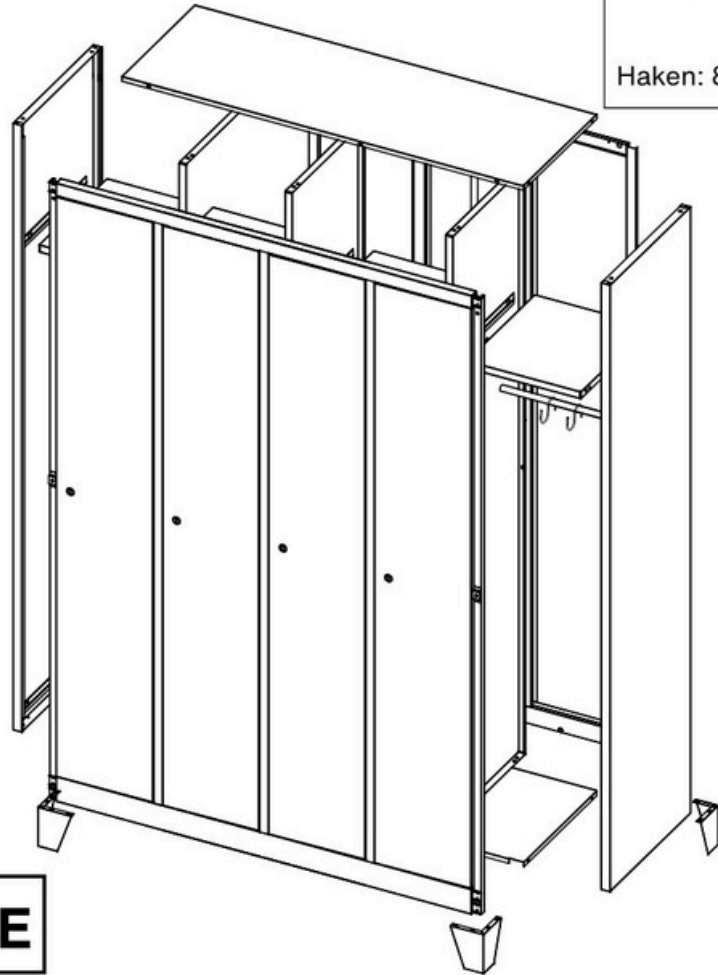

Haken: 8 Stk.

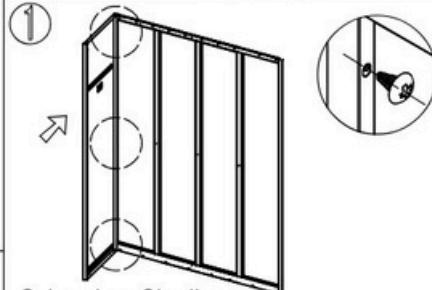

1 Schrauben Sie die linke Seite und die Rückwand mit selbstschneidenden Schrauben (5x10) zusammen.

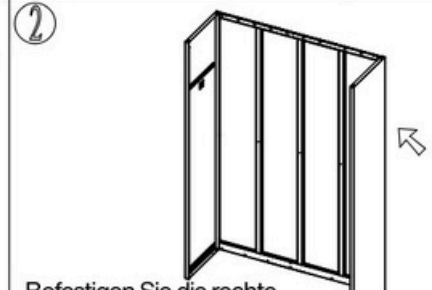

2 Befestigen Sie die rechte Seite auf die gleiche Weise wie im ersten Schritt an der Rückwand.

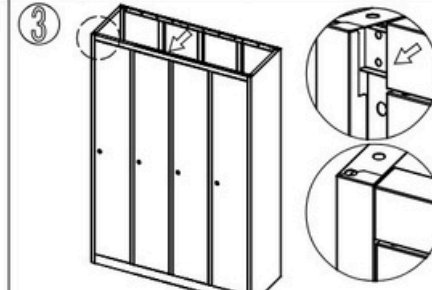

3 Befestigen Sie den Türrahmen an beiden Seitenplatten.

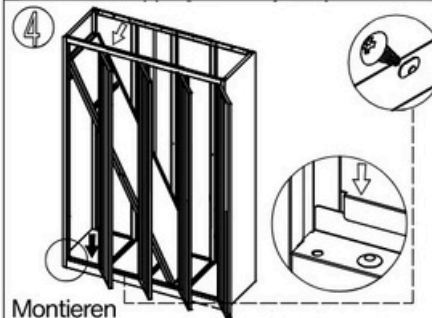

4 Montieren Sie die Bodenplatte und befestigen Sie anschließend die Trennplatte wie markiert.

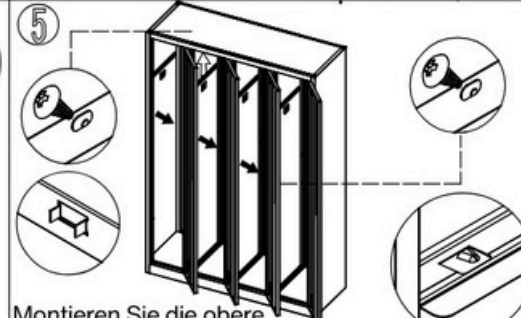

5 Montieren Sie die obere Platte und befestigen Sie anschließend die Trennplatte wie markiert.



6 Befestigen Sie die kleinen Regalböden wie markiert.

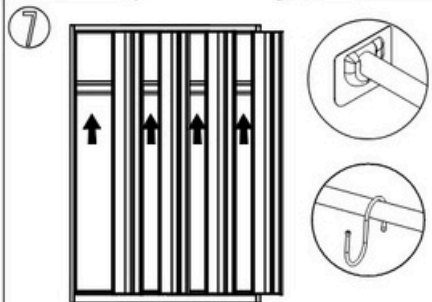

7 Montieren Sie die Kleiderstange und die Haken.

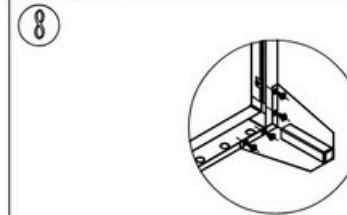

8 Montieren Sie die Standfüße mit Schrauben (5x10). Richten Sie nach der Montage alle Teile so aus, dass sie gut sitzen.

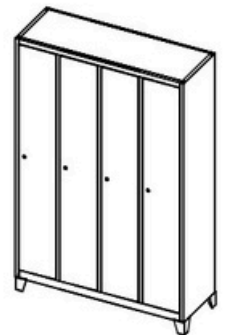



Left side: 1 pc



Right side: 1 pc

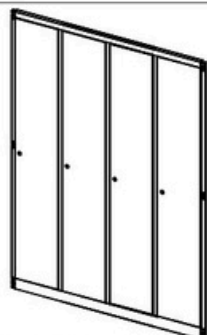

Door frame: 1 pc

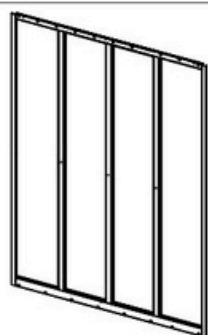

Back plate: 1 pc



Division plate: 3 pcs

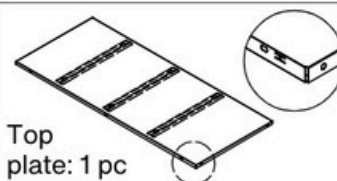

Top plate: 1 pc

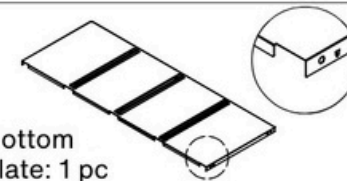

Bottom plate: 1 pc

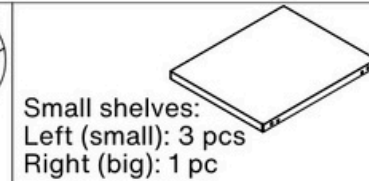

Small shelves:
Left (small): 3 pcs
Right (big): 1 pc



Self-tapping screw
ä5x10): 50 pcs



Standing feet: 4 pcs



Key: 4 sets

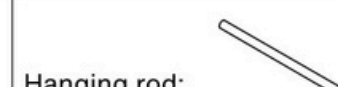

Hanging rod:
Left (short): 3 pcs
Right (long): 1 pc



Hook: 8 pcs

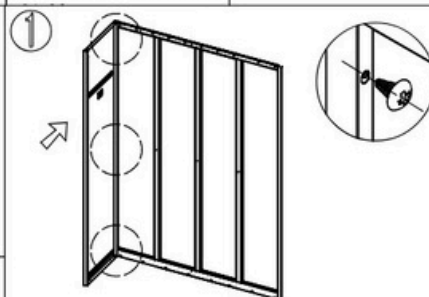
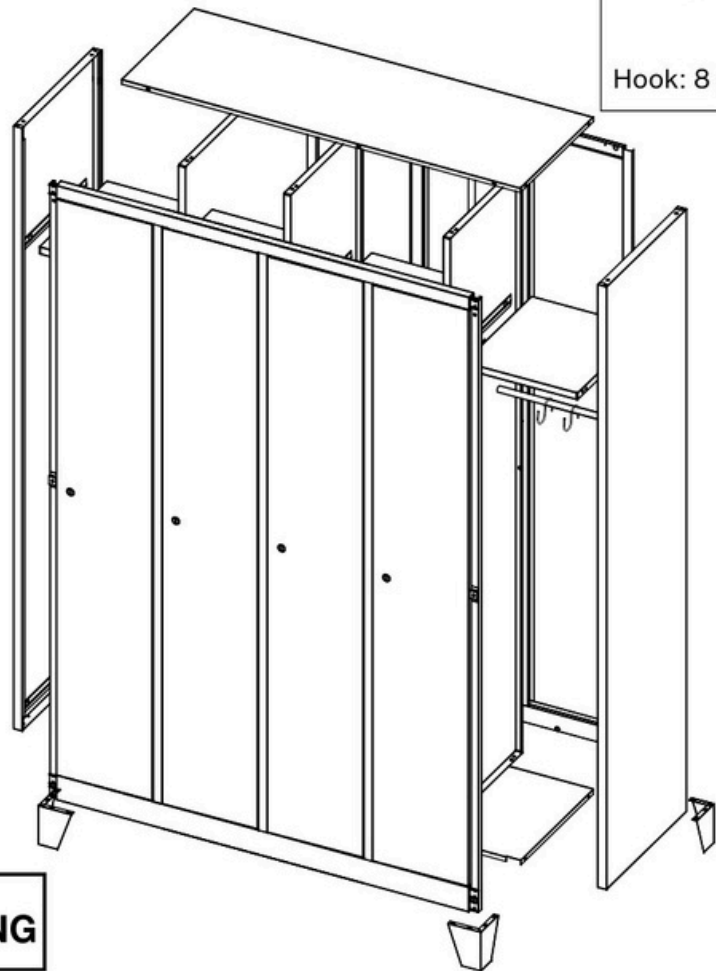

1 Bolt the left side and back plate with self-tapping screws (5x10).

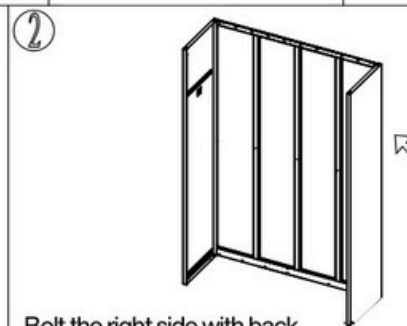

2 Bolt the right side with back plate in the same way as the first step.

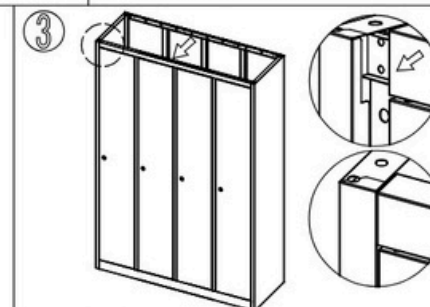

3 Fix the door frame onto both of the side plates.

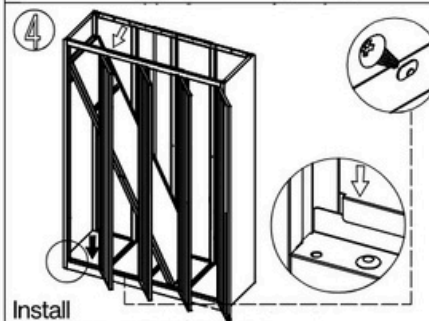

4 Install the bottom plate, then fix the division plate as the sign.

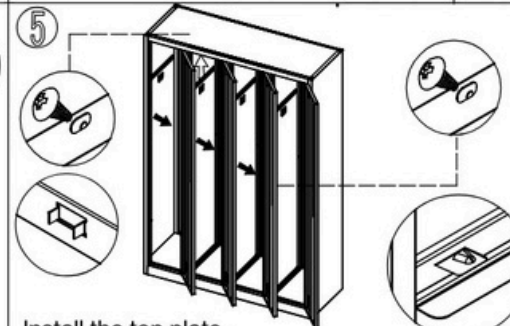

5 Install the top plate, then fix the division plate as the sign.

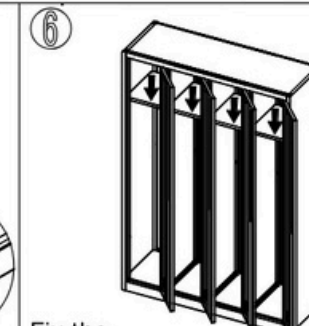

6 Fix the small shelves as the sign.

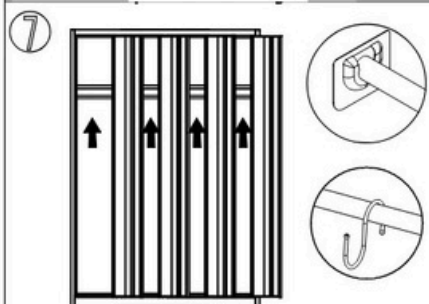

7 Install the hanging rod and hooks.

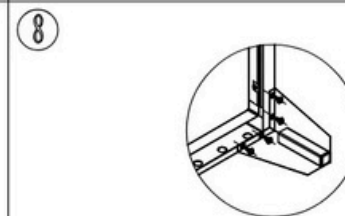

8 Install the standing feet with screws (5x10).



Adjust each part till fit well after installation.



Lewa strona: 1 szt.



Prawa strona: 1 szt.

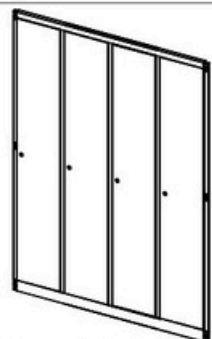

Rama drzwi: 1 szt.

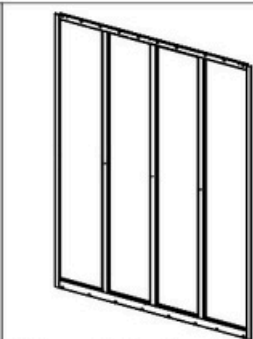

Tylna płyta: 1 szt.



Przegroda: 3 szt.

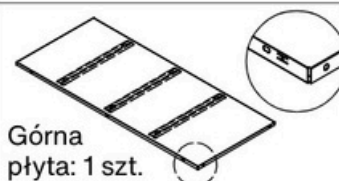

Górna płyta: 1 szt.

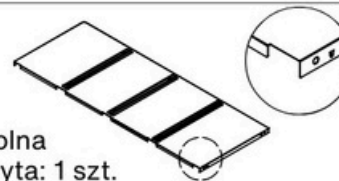

Dolna płyta: 1 szt.



Małe półki:
Lewa (mała): 3 szt.
Prawa (duża): 1 szt.

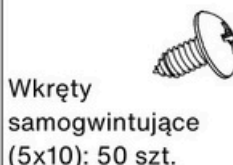

Wkręty
samogwintujące
(5x10): 50 szt.



Nóżki: 4 szt.



Klucze:
4 zestawy

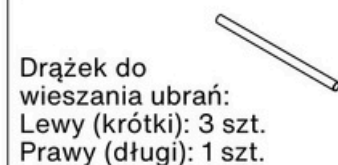

Drażek do
wieszania ubrań:
Lewy (krótki): 3 szt.
Prawy (długi): 1 szt.



Haczyki: 8 szt.

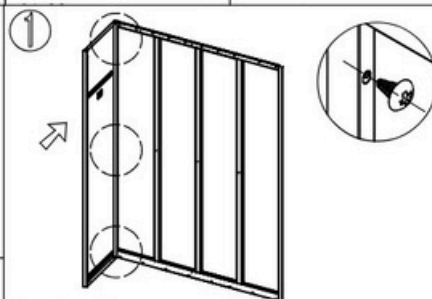
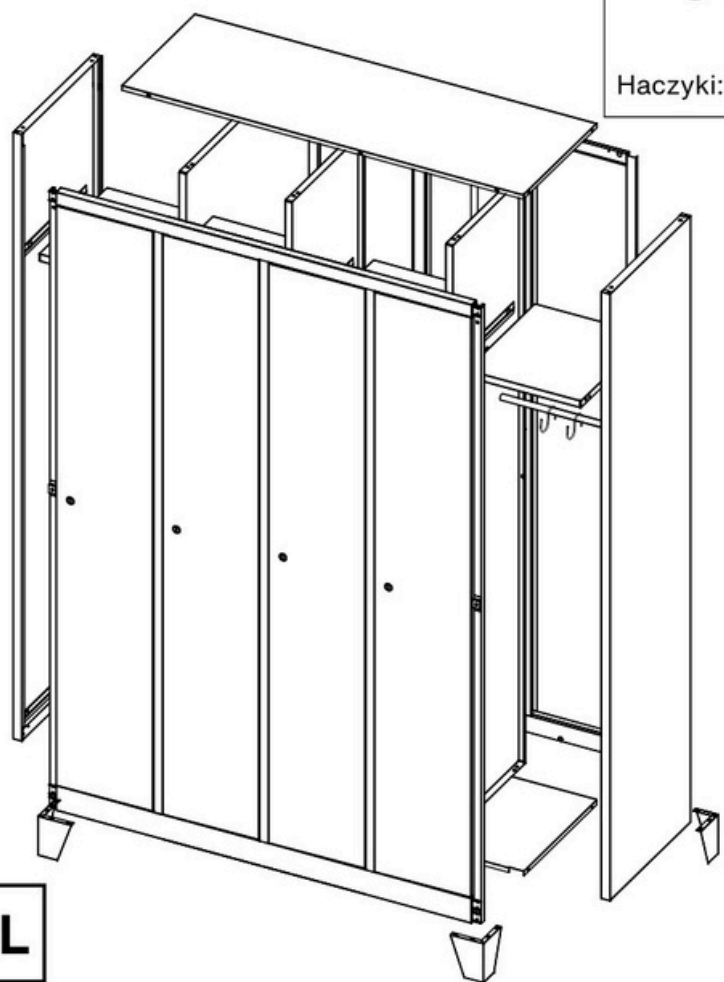

1 Przykręć lewą stronę i tylną płytę za pomocą wkrętów samogwintujących (5x10).

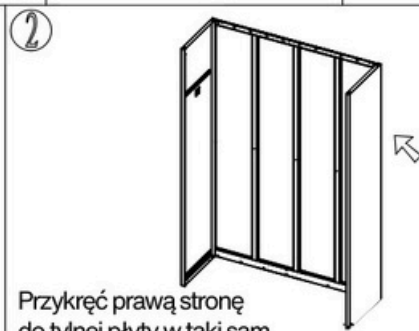

2 Przykręć prawą stronę do tylnej płyty w taki sam sposób jak w pierwszym kroku.

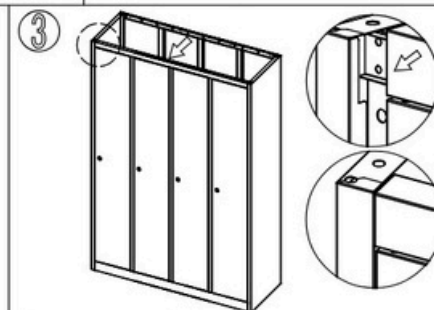

3 Przymocuj ościeżnicę drzwi do obu bocznych płyt.

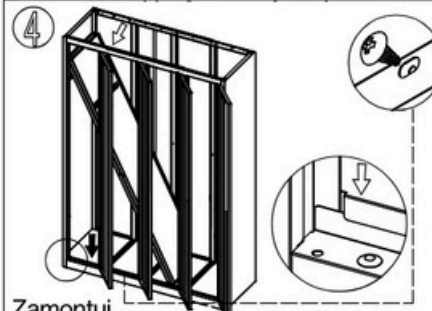

4 Zamontuj dolną płytę, a następnie przymocuj przegrodę zgodnie z oznaczeniem.

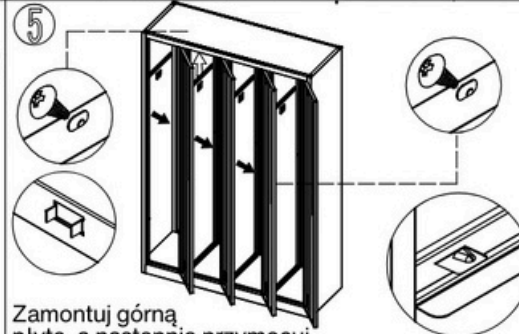

5 Zamontuj górną płytę, a następnie przymocuj przegrodę zgodnie z oznaczeniem.

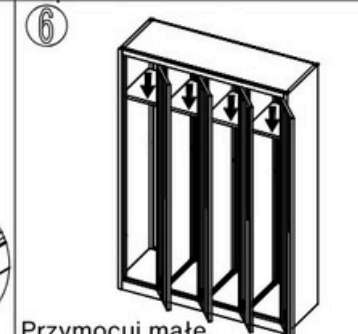

6 Przymocuj małe półki zgodnie z oznaczeniem.

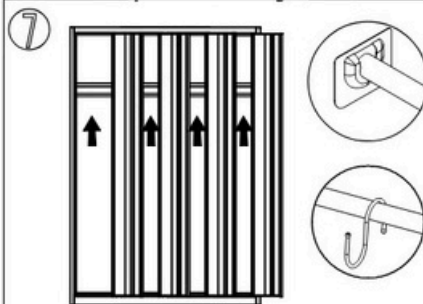

7 Zamontuj drążek do wieszania ubrań i haczyki.

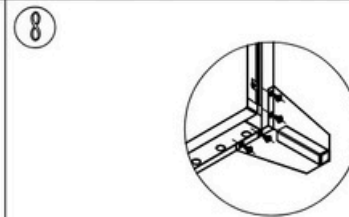

8 Zamontuj nóżki za pomocą śrub (5x10). Po montażu wyreguluj wszystkie części tak, aby dobrze pasowały.

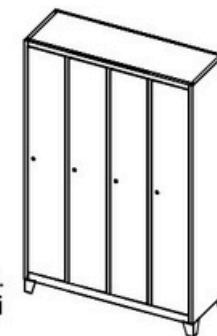

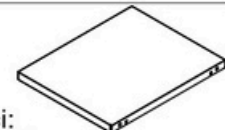
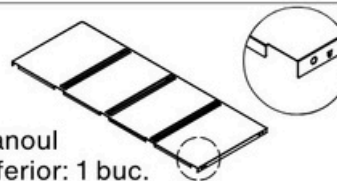
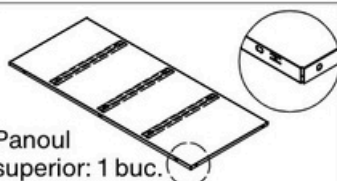
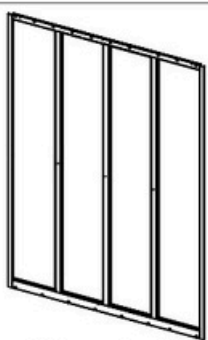
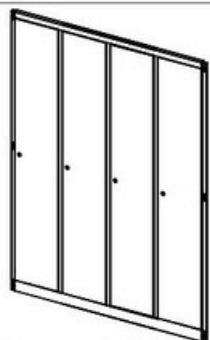
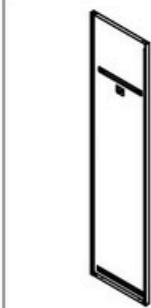

Partea stângă: 1 buc.

Partea dreaptă: 1 buc.

Rama uşii: 1 buc.

Panoul din spate: 1 buc.

Perete despărţitor: 3 buc.

Panoul superior: 1 buc.

Panoul inferior: 1 buc.

Rafturi mici:
Stânga (mică): 3 buc.
Dreapta (mare): 1 buc.



Şuruburi autofiletante
(5x10): 50 buc.



Picioare: 4 buc.



Chei: 4 seturi

Bară pentru
agăţarea hainelor:
Stânga (scurtă): 3 buc.
Dreapta (lungă): 1 buc.



Cârlige: 8 buc.

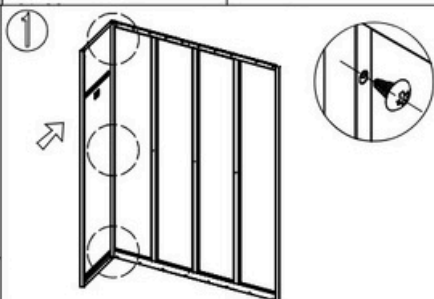
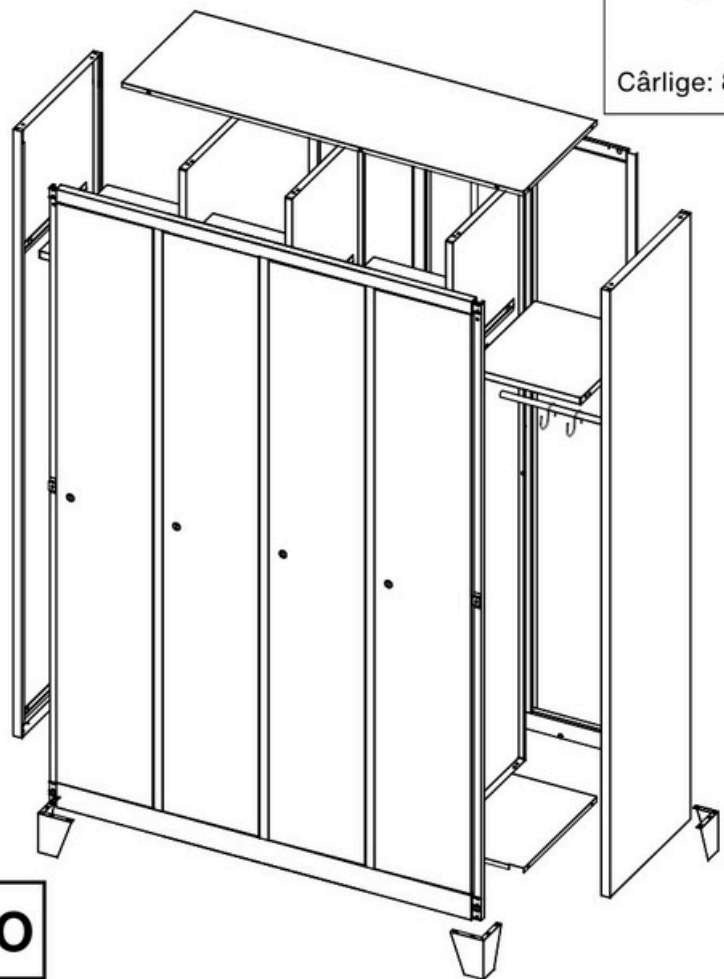

1 Înşurubaţi partea stângă şi panoul din spate folosind şuruburi autofiletante (5x10).

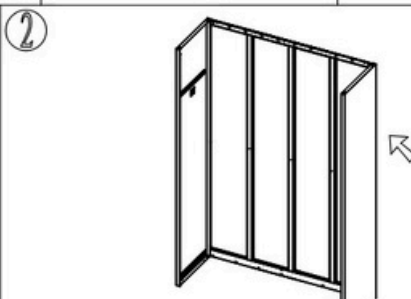

2 Fixaţi partea dreaptă de panoul din spate în acelaşi mod ca la primul pas.

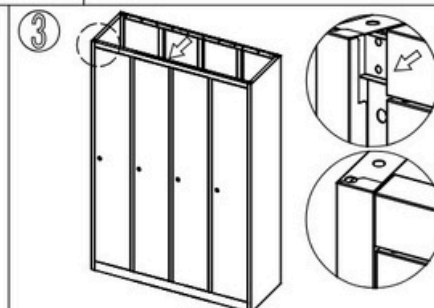

3 Fixaţi rama uşii pe ambele panouri laterale.

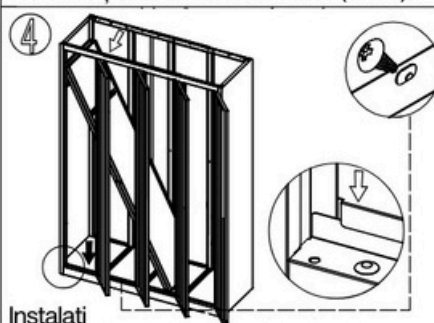

4 Instalaţi panoul inferior şi apoi fixaţi peretele despărţitor conform marcajului.

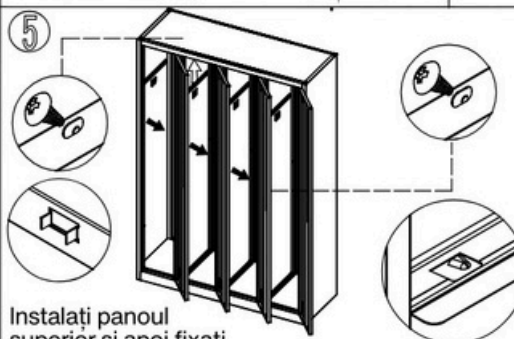

5 Instalaţi panoul superior şi apoi fixaţi peretele despărţitor conform marcajului.

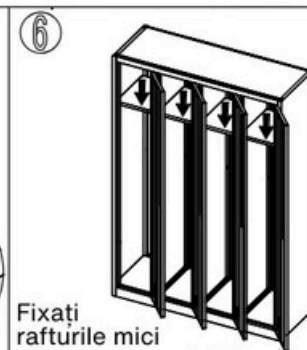

6 Fixaţi rafturile mici conform marcajului.

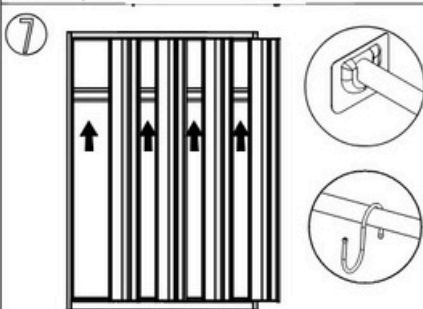

7 Instalaţi bara pentru haine şi cârlige.

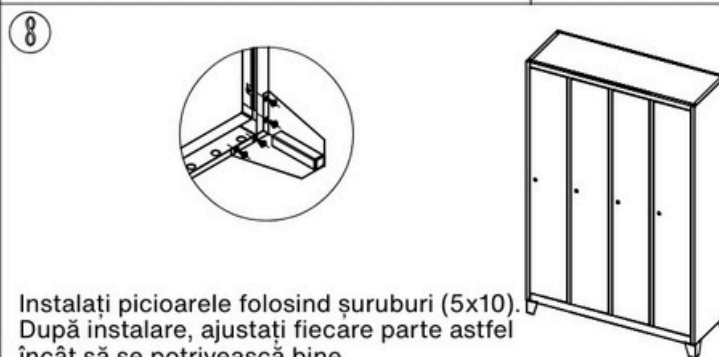

8 Instalaţi picioarele folosind şuruburi (5x10). După instalare, ajustaţi fiecare parte astfel încât să se potrivească bine.

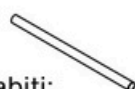
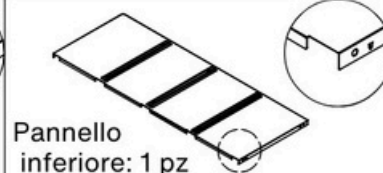
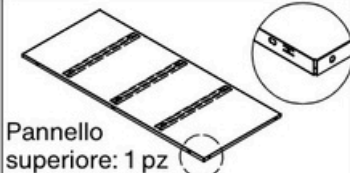
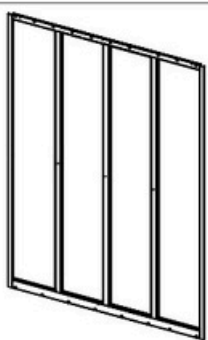
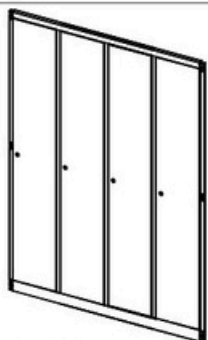

Lato sinistro: 1 pz

Lato destro: 1 pz

Telaio della porta: 1 pz

Pannello posteriore: 1 pz

Pannello divisorio: 3 pz

Viti autofilettanti (5x10): 50 pz

Piedini: 4 pz

Chiavi: 4 set

Barra appendiabiti:
Sinistra (corta): 3 pz
Destra (lunga): 1 pz

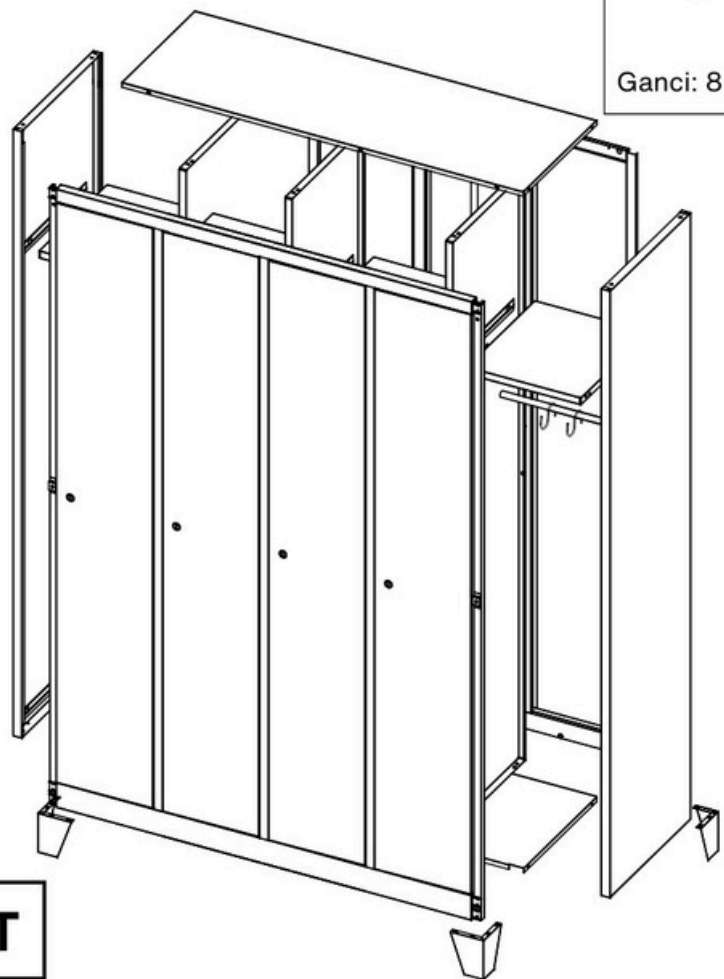

Ganci: 8 pz

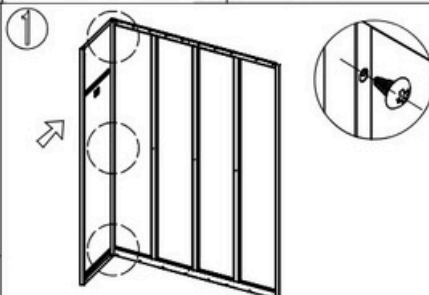

1 Avvitare il lato sinistro e il pannello posteriore utilizzando viti autofilettanti (5x10).



2 Fissare il lato destro al pannello posteriore nello stesso modo del primo passaggio.

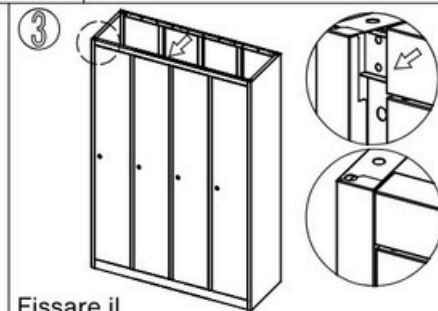

3 Fissare il telaio della porta a entrambi i pannelli laterali.

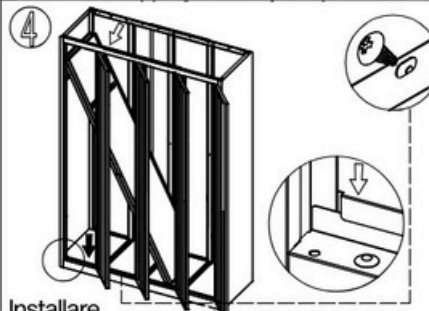

4 Installare il pannello inferiore e quindi fissare il pannello divisorio come indicato.

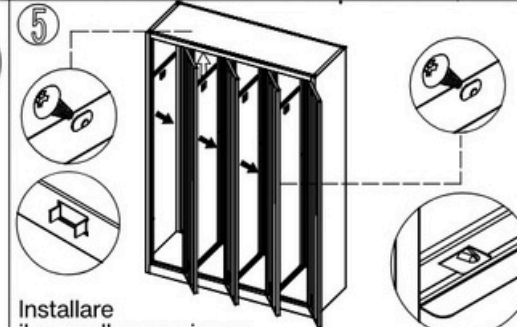

5 Installare il pannello superiore e quindi fissare il pannello divisorio come indicato.



6 Fissare i piccoli ripiani come indicato.

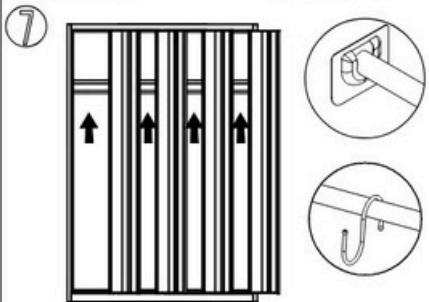

7 Installare la barra appendiabiti e i ganci.



8 Installare i piedini utilizzando viti (5x10). Dopo l'installazione, regolare ogni parte in modo che si adatti correttamente.